

Installation, use and maintenance manual

SMART 30 **Basic 12/24 V dc**



CE

INDEX

1. LAYOUT OF MANUAL.....	4
1.1 STRUCTURE OF THE MANUAL	4
1.2 DESCRIPTION OF THE PICTOGRAMS.....	4
2. GENERAL WARNINGS AND INFORMATION TO THE RECIPIENT	5
2.1 IMPORTANT INFORMATION	5
2.2 SAFETY WARNINGS	5
2.3 WARRANTY.....	6
2.4 IDENTIFICATION OF THE UNIT	7
2.5 LEGISLATIVE REFERENCE	7
2.5.1 DIRECTIVES AND STANDARDS CONCERNING MACHINE SAFETY.....	7
2.5.2 RESPECT FOR THE ENVIRONMENT – REQUIREMENTS FOR REMOVAL AND DISPOSAL.....	7
3. PRODUCT PRESENTATION	9
3.1 TRANSPORT AND MATERIAL HANDLING	9
3.2 STOCK.....	10
3.3 PACKAGING.....	10
3.3.1 PACKAGING CONTENTS.....	10
3.4 ATTACHED DOCUMENTS	11
3.5 TECHNICAL DATA	11
3.6 FEATURES OF THE PRODUCT	12
3.7 ADVANTAGES OF THE ENERGY RECOVERY SYSTEM	13
3.8 COMPOSITION OF THE MACHINE	14
3.8.1 PUMP GROUP.....	14
3.8.2 WATERMAKER GROUP.....	15
3.8.3 ACCESSORIES	17
4. MOUNTING AND INSTALLATION.....	18
4.1 GENERAL CRITERIA	18
4.2 COMPONENTS MOUNTINGS	19
4.2.1 PUMP GROUP.....	19
4.2.2 WATERMAKER GROUP	19
4.2.3 ACCESSORIES.....	19
4.3 INSTALLATION	19
4.3.1 WATER INTAKES AND DISCHARGES	19
4.3.2 SEAWATER INTAKE.....	20
4.3.3 FRESH WATER INTAKE FOR WASHING.....	21
4.3.4 BRINE DISCHARGE	21
4.4 HYDRAULIC CONNECTIONS	22
4.5 ELECTRIC CONNECTIONS.....	25
4.5.1 REMOTE CONTROL PANEL MOUNTING	25
4.5.2 ELECTRIC CONNECTIONS: WIRES (SMART 30 12/24V DC).....	26
5. FUNCTIONING AND USE.....	28
5.1 COMMAND DESCRIPTION.....	28
5.1.1 ALARMS DESCRIPTION	28
5.2 FIRST START UP PROCEDURE.....	28
5.2.1 PRELIMINARY CHECKS BEFORE PROCEEDING WITH THE STARTUP PROCEDURE	29
5.2.2 START UP	29
5.3 NORMAL OPERATING PROCEDURE	30

5.3.1	NORMAL OPERATING PROCEDURE WITHOUT FINAL FLUSHING	30
5.3.2	NORMAL OPERATING PROCEDURE WITH FINAL FLUSHING (RECOMMENDED PROCEDURE)	31
5.3.3	WORKING CYCLE WITH TIMER	31
5.3.4	LONG FLUSHING PROCEDURE.....	31
5.4	RESET PROCEDURE	32
6.	MAINTENANCE (ROUTINE AND SPECIAL).....	34
6.1	CHECK FILTER CLEANLINESS	34
6.2	CHECK THE PLANT WORKING PRESSURE	35
6.3	CHECK FOR LEAKS.....	35
6.4	CHECK FOR MEMBRANES REPLACEMENT	35
6.5	SHUTDOWN PROCEDURE	35
6.5.1	NECESSARY EQUIPMENT	36
6.5.2	SHUTDOWN OPERATING PROCEDURE.....	37
6.6	ANTIFREEZE PROCEDURE (WINTERIZING PROCEDURE IN COLD CLIMATE - UNDER 5°C).....	39
6.7	PERIODIC MAINTENANCE.....	40
6.7.1	MEMBRANE REPLACEMENT.....	40
6.8	ADJUSTMENTS	40
7.	TROUBLESHOOTING.....	41
7.1	TROUBLESHOOTING CHART.....	41
8.	SUGGESTED SPARE PARTS.....	42
8.1	SHORT TERM CRUISING.....	42
8.2	LONG TERM CRUISING	42
8.3	ERS SPARE PARTS	43
8.4	ADDITIONAL SPARES	44

1. LAYOUT OF MANUAL

1.1 Structure of the manual

The manual is divided into chapters, which gather all the information necessary to use the system without risk. Within each chapter there is a subdivision in paragraphs to focus on essential points; each paragraph can be pointed out with a subtitle and a description.

At the top of each page the heading section is reported in order to remind the reader the field of the page.

Within the chapter, for example chapter 1, we will have:

1	Chapter title
1.1	Paragraph title
1.1.1	Subtitle
1.1.1.1	Further subtitles

The numbering of the pages, figures and tables, is reset to each chapter; therefore, we will find the prefix indicating the chapter and the page number, figure or table in progressive that starts from number 1 at the beginning of each chapter.

1.2 Description of the pictograms

The following symbols will be used in the manual to highlight particularly important indications and warnings:



ATTENTION:

This symbol indicates accident prevention regulations for the operator and / or for any exposed persons.



CAUTION:

This symbol indicates that there is the possibility of damaging the system and / or its components.



NOTE:

This symbol indicates useful information.

2. GENERAL WARNINGS AND INFORMATION TO THE RECIPIENT

2.1 Important information

To safeguard the operator's safety and to avoid possible damage to the machine, before carrying out any operation on the machine, it is essential to read carefully all the instructions manual.

This manual must be complete and legible in its entirety, every operator involved in the use of the machine, or responsible for maintenance or adjustment operations, must know its location and must have the possibility to consult it at any time.

All rights of reproduction of this manual are reserved to SCHENKER ITALIA. This manual cannot be transferred to third parties without the written authorization of SCHENKER ITALIA.

The text cannot be used in other printed matter without the written permission of SCHENKER ITALIA.

The descriptions and illustrations provided in this publication are not binding.

SCHENKER ITALIA reserves the right to make any modifications it deems appropriate.

© SCHENKER ITALIA

THIS MANUAL IS PROPERTY OF SCHENKER ITALIA, ANY REPRODUCTION, EVEN PARTIAL, IS PROHIBITED.

This manual was drafted according to the requirements of the 2006/42 / EC Machinery Directive.

2.2 Safety warnings

- Wear protective equipment suitable for service operation.
- Do not remove safety devices or accident prevention protection.
- To check if the plant is correctly installed contact a Schenker service point.
- Verify that the electric and hydraulic connections are in keeping with the indicated specifications.
- Avoid using the plant if the sea water is polluted.
- Children and inexperienced people shall not touch or operate the plant.
- Check periodically that no leaks are present. Avoid installing the plant where a leak may cause damage and/or jeopardize the safety of the vessel.
- Maintenance should only be carried out by suitably qualified persons or Schenker personnel.



ATTENTION

Any technical changes or operating conditions indicated that affect the correct operation or safety of the machine must only be carried out by the manufacturer's technical staff or by technicians formally authorized by the manufacturer. Otherwise, SCHENKER ITALIA declines any responsibility for changes or damages that may result from it.

2.3 Warranty

The equipment and the relevant accessories are guaranteed 12 months from delivery. The guarantee does not include consumable items (filters, carbon filters, membranes, etc.). The "ERS" pressure amplification device is guaranteed 36 months, provided that the annual maintenance is performed at a Schenker service point.

The guarantee covers faults, defect of materials and parts. It is limited to the replacement or re-pair of faulty parts. The expense for the disconnecting and reinstalling on the vessel and transport of the equipment from or to our Service Point, or our factory will be at the customers own expense.

The under guarantee delivered parts transport, will be at customer's own risk.

In case of repairs under guarantee performed by our technicians on the customer vessel, the faulty parts replacement cost will be at Schenker's expense, while manpower and travel expenses will be charged to the customer. The guarantee does not include faults caused by negligence in operating, maintenance and installation of the device (if not carried out by an authorised Schenker Service point).

Dismantling by non-authorized personnel will render void all guarantees. Schenker Italia cannot be held liable for any direct or indirect damage caused by the malfunctioning equipment, limiting its responsibility to the repair and replacement of faulty parts.



ATTENTION

SCHENKER ITALIA declines any responsibility for improper use of the machine, for damages caused as a result of operations not covered by this manual or unreasonable use.

2.4 Identification of the unit

All the watermakers manufactured by Schenker Italia can be identified by a serial number printed on a label which is pasted upon the aluminium frame near the manometer. The same serial number is also recorded on the central black block of the energy recovery system (ERS).

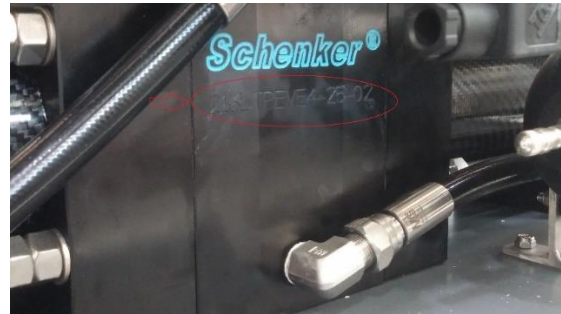

Serial number
Fig. 2-1

2.5 Legislative reference

2.5.1 Directives and standards concerning machine safety

- Machinery Directive 2006/42 / EC, in force since December 29, 2009;
- Low Voltage Directive 73/23 / EEC and subsequent amendments and additions: 93/68 / CEE implemented by the Law of 18 October 1997 n. 791.
- Electromagnetic Compatibility Directive 89/336 / EEC and subsequent amendments and additions: 93/31 / CEE implemented with D.L. December 4, 1992 n. 476.
- Standards UNI EN 292/1 and 292/2 (safety of machinery);

2.5.2 Respect for the environment – requirements for removal and disposal



ATTENTION

Removal and disposal of materials, as result of the decommissioning of the machine, must be performed in accordance with the regulations in force, for the safeguard and protection of the environment.

With regard to removal and disposal, it should be noted that the materials of which the machine is made of are not of a dangerous nature and consist essentially of:

- Stainless Steel;
- Aluminium;
- Plastic;
- Carbon fibre;
- Motors, cables and consumable electrical materials;
- Rubber and polyurethane seals.

After dismantling the machine, the various materials must be segregated according to the regulations of the country in which the machine has been removed.

The machine does not contain dangerous components or substances that require special removal procedures.



ATTENTION

Different legislations are in force in the different countries, therefore the prescriptions imposed by the laws and by the agencies designated by the Countries must be observed.

3. PRODUCT PRESENTATION



ATTENTION

Be sure to follow general safety instructions.

- Wear protective equipment suitable for the transport and handling operations.
- Lift the machines with equipment appropriate to the weight and size of the box, taking the utmost care and following carefully the instructions on the present use and maintenance manual (attachment points for loading devices, etc.).
- Make sure that the lifting equipment used is in good condition and correctly maintained.
- Do not stand or pass under the groups to be moved during lifting or transport operation.

3.1 Transport and material handling

The watermaker unit is transported in a cardboard box. In the following table dimension and weight are indicated.

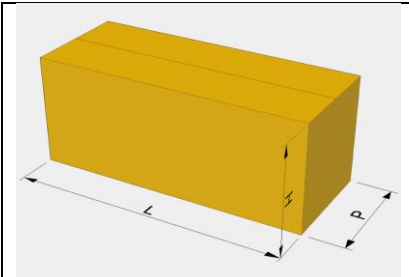

MATERIALS HANDLING
fig. 3-1

	Model	L cm.	W cm.	H cm.	Weight Kg.
	Smart 30 Basic	82	57	48	35

Packaging dimensions and weight
tab.3-1

3.2 Stock



ATTENTION

To avoid damage to the system, store the unit in a dry place at a temperature of between 5°C and 35°C. Very cold temperatures could lead to a freezing of the fluid inside the system with the consequence of a permanent damage of the system.

3.3 Packaging

3.3.1 Packaging contents



PACKAGING (sample picture)
FIG. 3-2

Smart 30	
Watermaker	Pump group
Active carbon filter with electrovalve	White filter key
Mesh filter	Non-return valve with Tee fitting
Remote panel	10 mt extension cable for remote panel
Intallation kit	Small metal parts
6x8 hose for production	Hose fittings

3.4 Attached documents

The packaging contains the technical documentation (use and maintenance manual, electric and hydraulic scheme, warnings and instructions).



ATTENTION

- Read carefully the use and maintenance manual before installing the system.
- Use only recommended material for the installation (especially hoses, fittings and seals) in accordance with the manual.
- Do not store the unit under temperature below 5°C and above 35 °C



DOCUMENTS INCLUDED IN THE PACKAGING (sample picture)
FIG. 3-3

3.5 Technical data

WATERMAKER GROUP

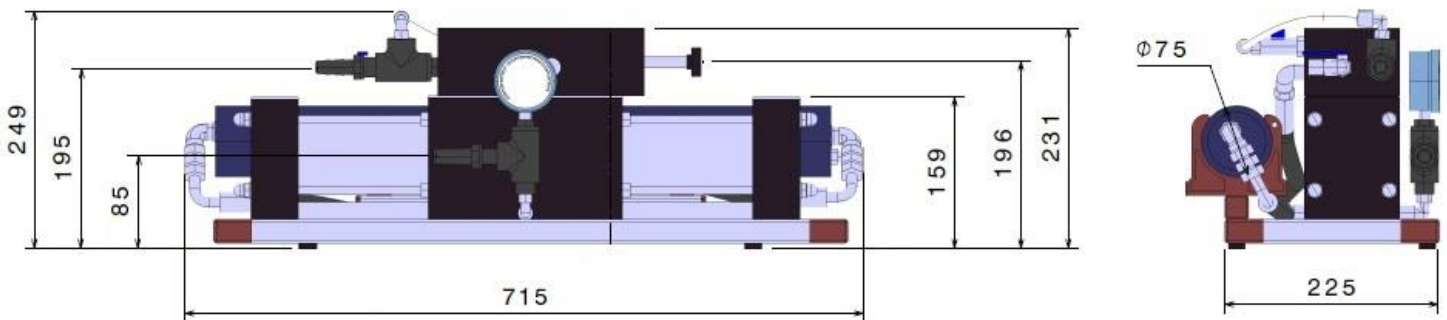

WATERMAKER DIMENSIONS
FIG. 3-4

Weight: 18 Kg

Hydraulic Connection

Seawater inlet: 3/4" fitting, 16mm internal diameter reinforced hose.
Exhaust: 1/2" fitting, 16mm internal diameter reinforced hose.
Fresh water: 1/4" fitting, 6x8mm hose.

PUMP GROUP

Dimensions

Length:	34 cm
Width:	20 cm
Height:	20 cm
Weight:	7 Kg

Hydraulic Connection

Water inlet:	¾" fitting, 16mm internal diameter reinforced hose.
Water outlet:	¾" fitting, 16mm internal diameter reinforced hose.

Feed pump type: Shurflo diaphragm pump

Filters: n. 1 Cartridge filter 5 microns 2.32" x 9 ¾"
n. 1 Active carbon filter 2.32" x 9 ¾"

Power supply: 12 VDC +/- 15% (30S12 version)
24 VDC +/- 15% (30S24 version)

Average electric consumption: 110 Watt/h average

Nominal fresh water production: 30 Lit/h +/- 20% @ seawater 25 °C salinity 35.000 ppm

CEE conformity: In compliance with directives 89/392 CEE sect.1 (general safety machines requirements), 89/336 CEE (electromagnetic compatibility), 73/23 CEE (electric safety requirements)

3.6 Features of the product

The water produced by a Schenker plant, produced from clean seawater has a high purity but the potability may not be guaranteed as bacterium may be present in the watermaker, caused by non-observance of shutdown and cleaning procedures. It is essential that correct shut down and storage procedures are followed to ensure continued purity of the product water. UV treatment of the product water may be beneficial.

3.7 Advantages of the Energy recovery system

Introduction

Thank you for choosing a Schenker Watermaker.

As all the equipment, the knowledge of operating and maintenance procedures allows to use the system in the best way, and to guarantee a perfect functioning throughout the years. We invite you to read carefully this manual and to keep it for a quick reference.

Functioning principles

The Schenker watermakers, as alternative to the high-pressure pumps of traditional systems, utilizes the ENERGY RECOVERY SYSTEM patented device, which amplifies the pressure of common low-pressure pumps, and recoup all the hydraulic energy back from the membranes, allowing a high energy efficiency.

The lack of high-pressure pumps makes the system silent and vibrations free, and enormously simplifies the use as no adjustment is necessary for its operating.

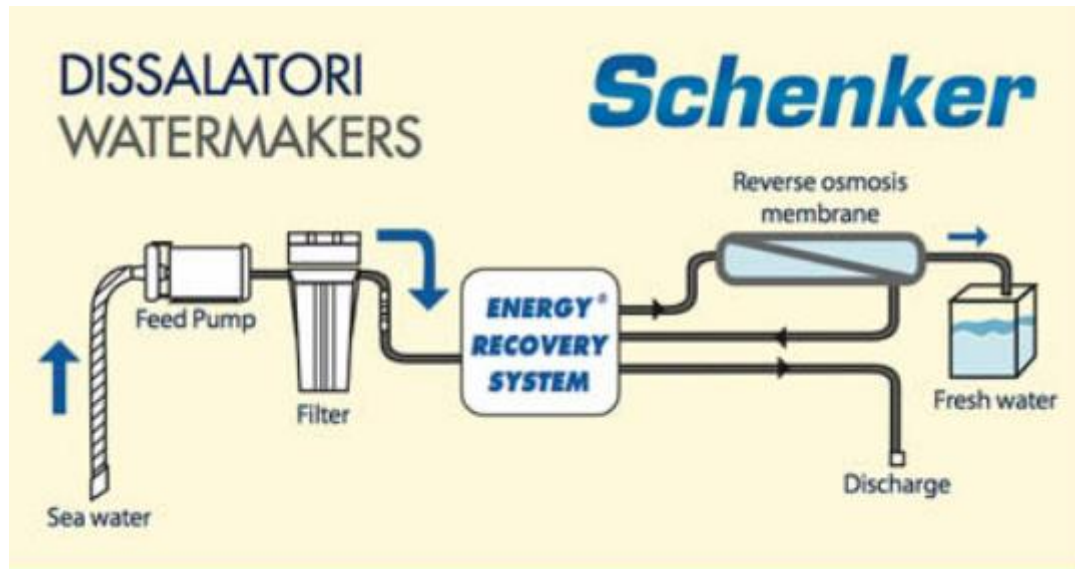

FUNCTIONING SCHEME
FIG. 3-5

3.8 Composition of the machine

The machine is composed of the following parts:

1. PUMP GROUP

2. WATERMAKER GROUP

3.8.1 Pump group

This pump has the duty of picking the sea water up and send it to the watermaker group, through the pre filter. The pump group is composed of the following parts:

- 5 micron cartridge filter
- Diaphragm pump
- Pressure transducer
- Pump box
- Accumulator

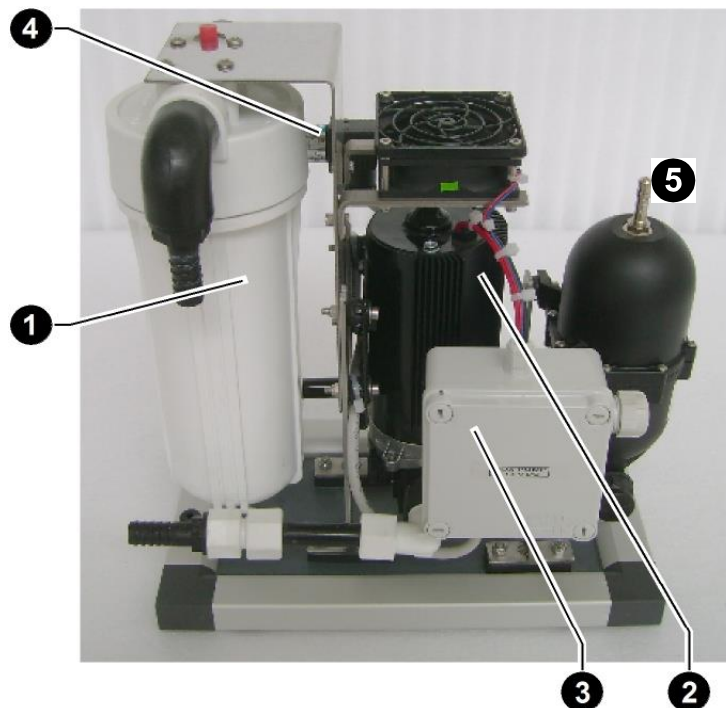

PUMP GROUP AND FILTER 12-24 V DC
FIG. 3-6

- ① 5 micron cartridge filter
- ② Diaphragm pump
- ③ Pump box

- ④ Pressure transducer
- ⑤ Accumulator

3.8.2 Watermaker group

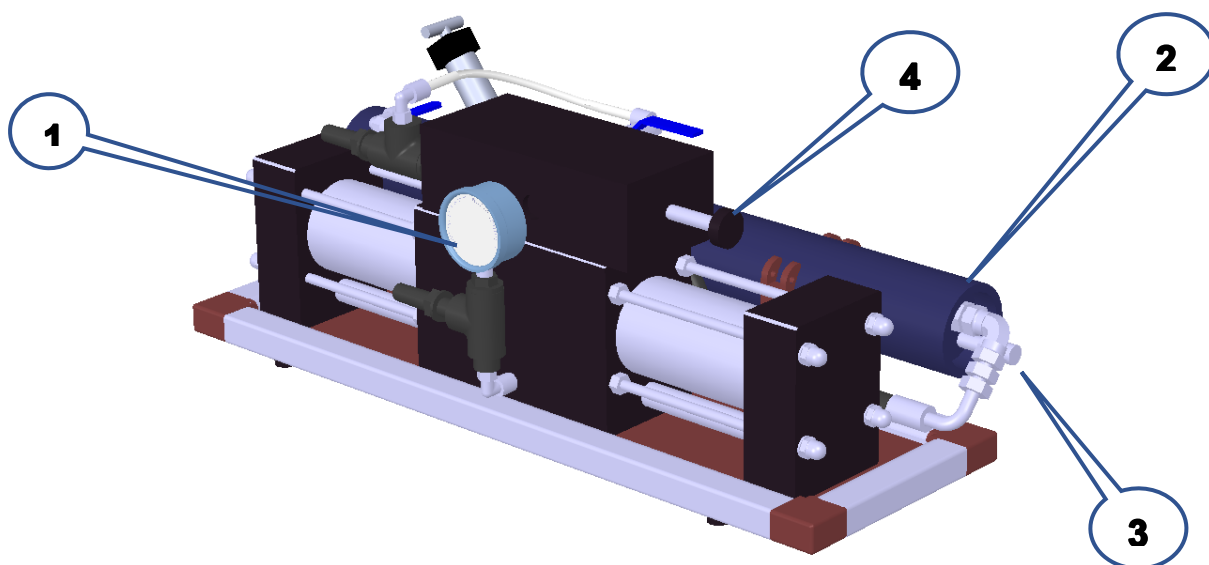

WATERMAKER GROUP
FIG. 3-7

- ① Manometer
- ② Reverse osmosis membrane
- ③ Fresh water production hose
- ④ Positioner knob

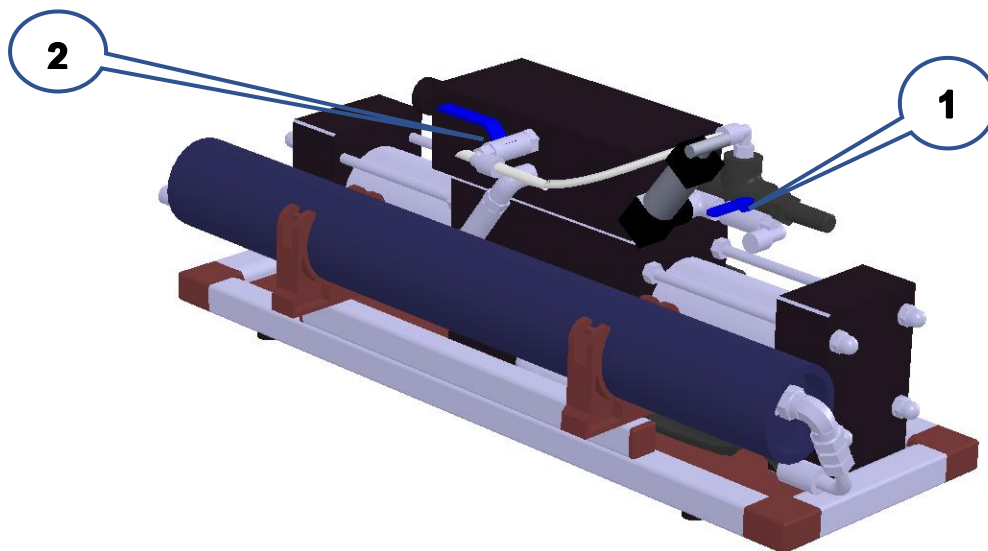

WATERMAKER GROUP (BACK VIEW)
FIG. 3-8

- ① Reset valve
- ② Depressurization valve

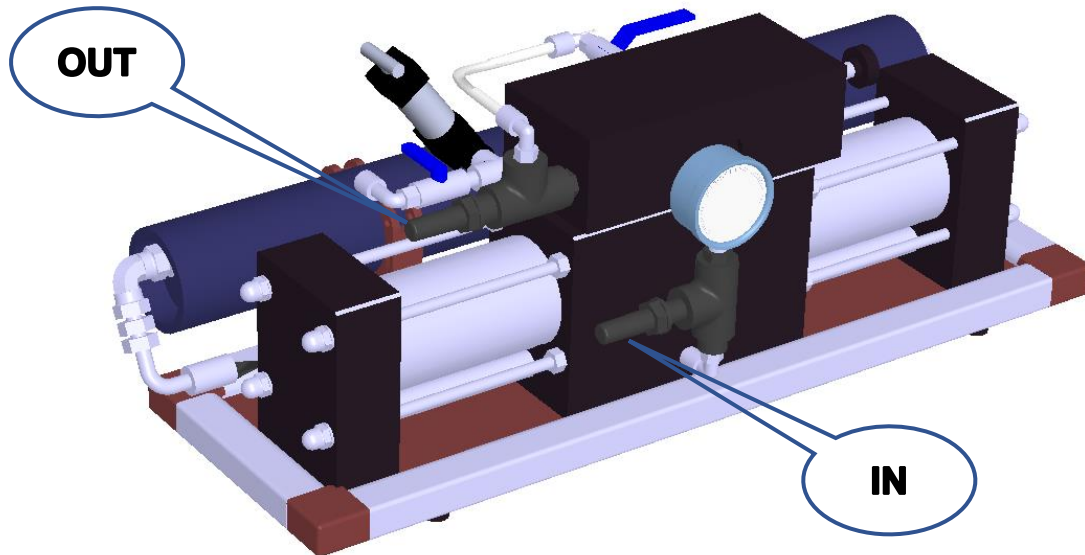

CONCENTRATE OUTLET (OUT) AND SEAWATER INLET (IN)
FIG. 3-9

The watermaker group is composed of the following parts:

- Reverse osmosis membranes
- Energy Recovery System
- Manometer
- Accumulator
- Depressurization valve
- Positioner
- Reset valve
- High pressure switch

Reverse osmosis membrane. It is installed inside the glass fibre high-pressure housing. Membrane is n.1 x SW2521 type. Its purpose is to separate the intake high-pressure seawater in two flows: one for the salt-water drain and one for the fresh water production.

Energy Recovery System. It is the black, carbon fibre unit. It has the function to amplify the pressure supplied by the pumps and to recoup the hydraulic energy back from the membranes. The ERS device makes periodic cycling by a hydraulically controlled automatic valve. The cycles are noticeable through a "beat" issued periodically by the watermaker unit. The unit is based on cylinders and a central body containing the hydraulic valve necessary for the system functioning.

Manometers. It is located on the front panel of the watermaker, and it measures the working pressure of the watermaker.

Accumulator. It is a black plastic reservoir of air, installed in the pump group. Its function is to reduce and stabilize the pressure peaks during the watermaker functioning. The device has to be pre-charged with air through the specific valve. The air pressure precharge is about 4 Bar. The pressure dimmer is charged in factory at the right pressure.

Depressurization valve. It is used for the air bleeding of the unit. It is recognizable by a blue lever and it is located on the top side of the watermaker fitted on the top valve of the ERS. Its function is to depressurize the system and to allow the bleeding of air. The valve must be closed during normal working conditions (vertical position), and it is opened during the air bleeding operations (horizontal position).

Positioner. It is a stainless steel threaded arm, with a black knob, located on the right side of the watermaker. Its function is to reset the unit in case of hydraulic block.

Reset valve. It is installed on top of the ERS it is recognizable by the little blue plastic lever. The valve must be closed during normal functioning (lever perpendicular to the valve). Such valve has the function to allow the reset of the ERS in case of a system block. It must be opened before acting on the valve positioner.

High pressure switch. It is hydraulically connected with the pump group. It stops the system if the pump pressure exceeds 9,5 bar. In this case a high-pressure alarm is activated on the control panel.

3.8.3 Accessories

The main accessories of the watermaker are the following:

- Active carbon filter
- Electrovalve
- Non-return valve
- Mesh filter (strainer)

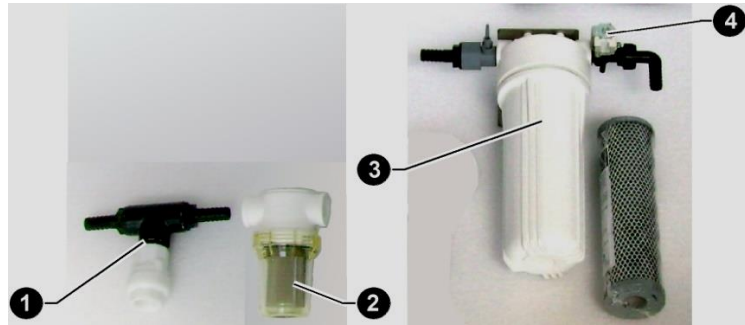

ACCESSORIES
FIG. 3-10

- | | | | |
|---|------------------------|---|----------------------|
| ① | Non-return valve | ③ | Active carbon filter |
| ② | Mesh filter (strainer) | ④ | Elettrovalve |

Active carbon filter. This filter is connected between the fresh water pressurized system of the vessel and the electro valve on the filter holder. On the filter inlet is positioned a manual valve that allows to replace the cartridge without depressurize the fresh water system of the vessel.

Electrovalve. It has the function of switching from seawater intake to fresh water tank when washing the watermaker.

Non-return valve. It avoids the emptying of the inlet hoses. It must be installed vertically. It avoids also the leak of fresh water from the seacock while washing procedure.

Mesh filter: The machine is equipped with a strainer to protect the pump from macro sediments. It is placed between the seacock and pre-pump.

4. MOUNTING AND INSTALLATION

4.1 General criteria

Before starting with the installation, it is important to carefully plan all the activities, by evaluating all the possible solution to be adopted. The main points to focus on are the following:

- Individuate the seawater inlet
- Positioning of the main units (pump group, watermaker group, active carbon filter).
- Positioning of the thermal-magnetic circuit breaker.
- Passage of the hoses and electric cables.



CAUTION

For a correct installation of the watermaker, in order to avoid issues along the different ways of operating condition, please follow carefully the general instruction below:

- *Consider to install the through-hull fitting in a central and deep position, in the way that no air could be aspirated.*
- *The non-return valve has to be installed under the seawater level and as close as possible to the through-hull fitting, in vertical position.*
- *The pump must be installed as low as possible respect to the seawater level and as close as possible to the seawater intake (through-hull fitting).*
- *The watermaker unit must be horizontally positioned, and arranged on an adequate support which is able to sustain the weight (about 25 Kg).*



CAUTION

The pump group must be installed in a ventilated place, in order to facilitate the cooling. In addition to this, a place not exposed to condensation and dripping should be adopted.



ATTENTION

The external surface of motor and pump can reach high temperature; therefore, it is recommended to avoid any contact with inflammable liquids and materials.



NOTE

Once individuate the correct installation solution, it is recommended to first make a schematic draft of the hydraulic and electric connection, and attach them to the present manual for future needs as first reference.

4.2 Components mountings

4.2.1 Pump group

The diaphragm pump must be installed as low as possible respect to the seawater level and as close as possible to the water inlet; furthermore, the pump cannot run dry.

The pump group should be installed in an adequately ventilated room, with the purpose to facilitate the cooling of the motor, and not subject to condensation or drippings. **The max permitted room temperature must not exceed 45°C.**

Avoid the contact or the proximity with inflammable material or liquid, since the motor surfaces can reach elevated temperatures. Avoid locating the pump wherever a possible loss of water can involve damages or jeopardize its safety. The pump must be installed on a base sufficiently horizontal, suitable to sustain the weight of the group. The pump is normally fixed on the support structure by passing bolts.

4.2.2 Watermaker group

Concerning the watermaker unit installation there are not height limits respect to the seawater level. Anyway, it should be installed above the pump.

Avoid to install the system wherever any possible leak may cause damages to the vessel or jeopardize its safety, since possible leaks due to accidental causes (hose bursting, hose clamp loosening, equipment failure, etc.) may cause water losses.

The hydraulic intake and outlet connections are positioned on the left of the unit. Therefore, it is necessary to foresee a minimum distance of 20 cm. to allow the hoses laying. The watermaker unit must be installed on a base sufficiently horizontal, suitable to sustain the weight of the group. **The max allowed room temperature must not exceed 40°C.** It is advisable to install the unit in such position to make the instrumentation easily visible, and make the valves (located on the right of the unit) easily accessible. The watermaker is normally fixed on the support structure by passing bolts.

4.2.3 Accessories

The non-return valve has to be installed vertically as close as possible to the seawater intake, following the direction of the arrow.

The active carbon filter (and the attached electrovalve) has to be placed next to the pump group, if possible, on a vertical side easily accessible.



4.3 Installation

4.3.1 Water intakes and discharges

For a correct installation of the watermaker it is necessary to arrange the following water intake and discharge out of the board:

- Seawater intake.
- Fresh water intake for washing.
- Brine discharge.

4.3.2 Seawater intake

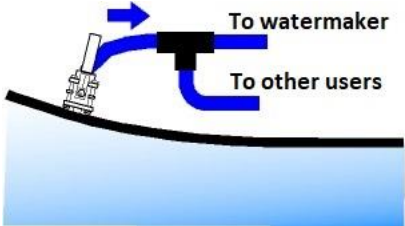
<p>Seacock with through-hull fitting</p>	<p>It is ideal a specific sea water intake, size 3/4" minimum in a central position, well under the water surface even when the vessel is well heeled over. The skin fitting is recommended. It must be oriented to the bow of the vessel. In case of high speed vessel (over 15 knot) it is advised to make some holes on the backside of the shape, in order to reduce dynamic prevalence during navigation.</p>	<p>Size 3/4"</p> 
<p>Pre-existing seacock adapting (alternatively)</p>	<p>As alternative, it is possible Tee into a pre-existent water inlet as long as the following conditions are met:</p> <ul style="list-style-type: none"> • 3/4" minimum size; • No air can be introduced into the system from other use ie: salt water taps in galley; • Must always be under the water surface even when the vessel is well heeled over. • Must be far from WC discharge. <p> CAUTION <i>Do not use the pre-existing water inlet of the cooling system dedicated to the motor.</i></p>	<p>Size 3/4"</p> 



INSTALLATION NOTES

- Allow a minimum 3/4" on-off ball valve on the water intake.
- The hose connections, especially if under the seawater level, must be secured with double hose clamps.
- An easily inspected mesh type filter will be required close to the water intake. The filter has to be of 50 microns. It is possible to use filters from existing outlets.
- The seawater intake must be at least 3/4" size.
- Downstream the seawater intake must be installed a strainer filter and a non-return valve. The water flow inhaled by the watermaker is about 6 lit/min.

<p>Mesh Filter</p>		
<p>Pre existing strainer)</p>	<p>In case of pre-existing mesh filter, it is possible to use it as long as the following conditions are met:</p> <ul style="list-style-type: none"> • Flow rate capacity of the filter is adequate to the whole intakes it serves. • No air is collected in the filter 	<p>Filtration grade of the strainer is 50 mesh.</p>



INSTALLATION NOTES

The filter has to be connected next to the through-hull fittings, and must be easily accessible for inspection.

4.3.3 Fresh water intake for washing

<p>Fresh water intake for washing</p>	<p>Tee in downstream of the vessel's fresh water pressure system. The following conditions must be respected:</p> <ul style="list-style-type: none"> • The flow of the existing fresh water pump must be min 6 lit/min. • Flushing must always be performed with the pressure water system ON. 	<p>Min. flow rate must be 6 lit/min. at 1 bar.</p>
--	---	---

4.3.4 Brine discharge

<p>Salt water discharge</p>	<p>The salt-water drain shall be ½" minimum size and it has to be preferably above the seawater level.</p>	<p>Minimum size ½"</p>
<p>Pre-existing salt water discharge (alternatively)</p>	<p>It is possible to use offtakes from existing apparatuses, provided that:</p> <ul style="list-style-type: none"> • It is not the engine cooling water drain or apparatuses that drain out water with elevated pressure. 	

4.4 Hydraulic connections

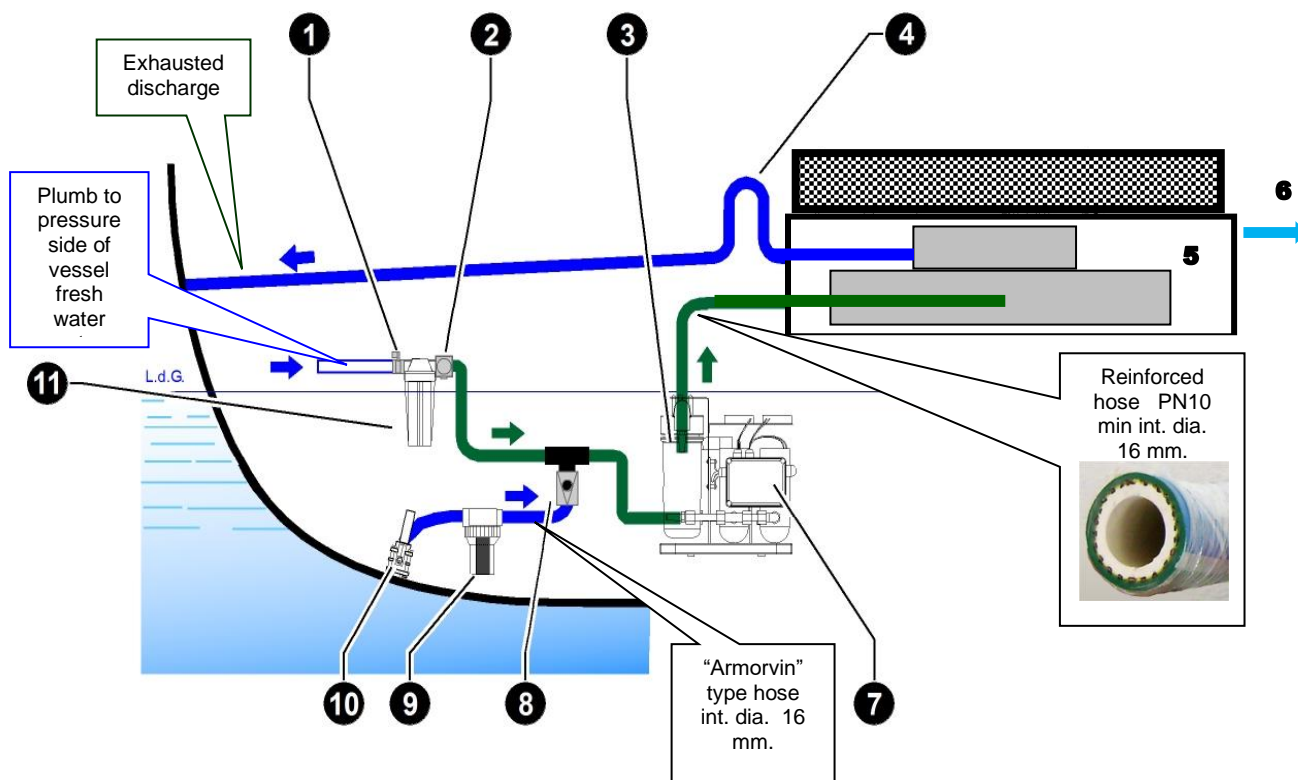

HYDRAULIC CONNECTION AND HOSES

FIG. 4-1

- | | |
|---------------------------------|------------------------|
| ① Pressurized fresh water valve | ⑦ Pump |
| ② Electrovalve | ⑧ Non return valve |
| ③ 5 micron filter | ⑨ Mesh filter |
| ④ Swan neck upward - Discharge | ⑩ Water inlet |
| ⑤ Watermaker | ⑪ Active carbon filter |
| ⑥ Fresh water outlet | |

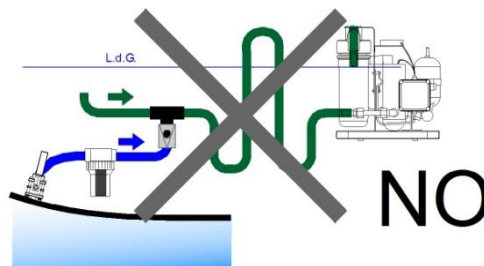
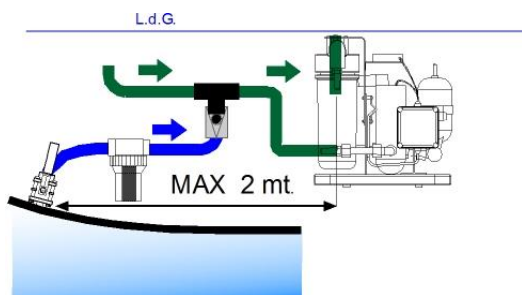

All the hydraulic connections (to exception of the fresh water production) have to be realized with a 16 mm. int. diam. hose and a 1/2" holder. The hydraulic section that is continuously under consistent pressure is the pump outlet – 5 m. filter – watermaker inlet connections . For this section is necessary to use a good quality **PN 10 min.** reinforced hose. An inadequate hose could burst, jeopardizing seriously the safety of the vessel.

The hydraulic connections are:

<p>Low pressure connections – max 3 bar</p>	<ul style="list-style-type: none"> • Connection between seawater intake – mesh filter – non-return valve inlet – pump group 	<p>Armorvin reinforced hose PN6 with 16mm internal diameter</p>
<p></p>	<ul style="list-style-type: none"> • Connection between the discharge of the watermaker – through hull discharge fittings of the vessel 	<p>Armorvin reinforced hose PN6 with 16mm internal diameter</p>
<p>Medium pressure connections – max 10 bar</p>	<ul style="list-style-type: none"> • Connections fresh water pressurized system– carbon filter–backflow valve outlet–pump inlet • Connections pump outlet–5 microns filter–watermaker inlet. 	<p>Rubber reinforced hose PN 10 minimum, internal diameter 16 mm.</p>
<p>Low pressure connections - max 3 bar</p>	<ul style="list-style-type: none"> • Watermaker - fresh water tank 	<p>1/4" fittings, Small plastic blue hose 6x8mm provided within the scope of supply</p>



PUMP CONNECTIONS:

Connect the in/out hose to the pump as follows:

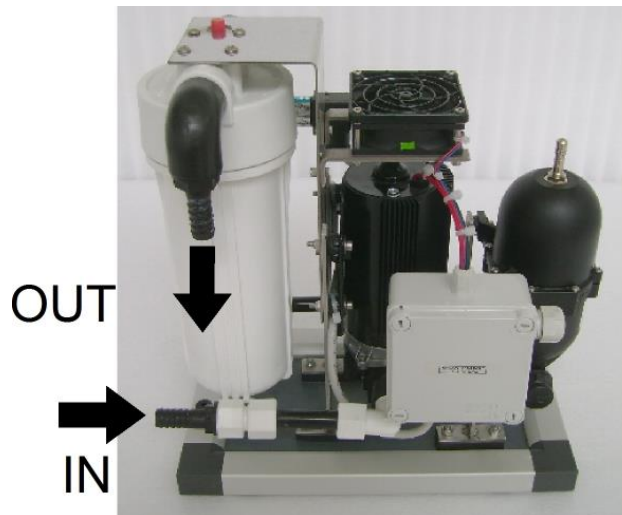

WATERMAKER INTAKE AND DISCHARGE
FIG. 4-2



CAUTION

The pump has to be placed as close as possible to the seawater intake and as low as possible respect to the seawater level; furthermore, it is recommended to avoid long and convoluted path of the connection hoses.



ATTENTION

The use of an improper hose can cause a break which prevent the security of the vessel.

WATERMAKER CONNECTIONS:

WATERMAKER INLET (Sea water inlet from the pump):

Make use of the external holder located on the left side of the watermaker (marked **IN**).

WATERMAKER OUTLET (Discharge outboard):

Make use, for this connection, of the holder located on top of the pressure amplifier, inside the watermaker unit (marked **OUT**). Create a Swan neck upward, when the drain outlet on the vessel is positioned below the watermaker unit, in order to guarantee a water head.

PRODUCTION FRESH WATER CONNECTION

The connection has to be made using the small hose supplied with the equipment. The connection has to be made between the polyethylene hose that comes out the watermaker unit (on the right), and the upper side of the tank, on a 1/4" outlet if available.

It is possible, in case of metal tanks, to make a 1/4" threaded hole to connect the supplied male connector.

Another option is to Tee into the tank air vent hose. There are no particular limits on the connection length.

Another option is to Tee into the tank air vent hose. This is only possible if the breather hose section is more than 16 mm. dia. There are no particular limits on the connection length.

4.5 Electric connections



ATTENTION

These steps have to be performed by a qualified technician/operator, by referring to the electrical drawings provided within this document.

4.5.1 Remote control panel mounting

The remote control panel has the following dimensions:

width 100 mm. height 66 mm.

It can be fixed on any internal vessel panel, provided that the area behind is free of humidity and condensation and there is enough depth to house the rear part of the panel (approx. 50 mm.).

The cut to be performed on the vessel covering panel, to encase the remote control panel, has the following dimensions:

width 80 mm. height 50 mm.

The remote control panel can be connected through the pre-wired multiple cable of a 10mt standard length provided. It is possible to adapt the panel to a longer distance by adding a one more cable in series to the one provided.

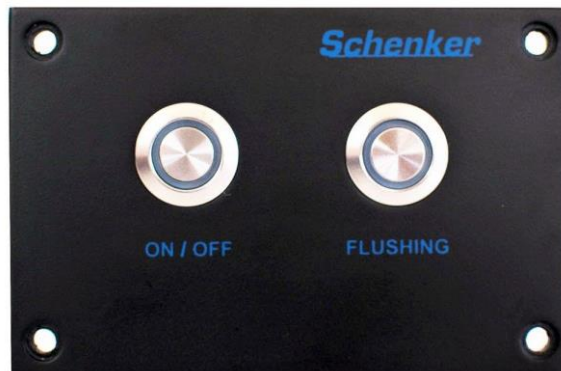

REMOTE CONTROL PANEL
FIG. 4-3

4.5.2 Electric connections: wires (SMART 30 12/24V DC)

The 12/24 V power supply, from the service batteries, must be connected to the +/- clamps on the card of the computer box. A 16 Ampere automatic circuit breaker for 12V systems must be installed on the power supply, while a 10 Ampere for 24V systems.

The connection must be suitable to take the typical electric load (110-120Watt continuous)

The power supply cable section is related to the length of the cable. See the diagram of the recommended sections below.

Voltage	Automatic switch	Cable length					
		up to 3 mt		3 - 7 mt.		7-10 mt.	
Volt	Ampere	mm2	AWG	mm2	AWG	mm2	AWG
12	16	4	11	10	7	16	5
24	10	2,5	13	4	11	4	11

The connection diagram in the computer box is the following:

<i>Clamp</i>	<i>connect to</i>	<i>cable section</i>
-	Negative battery	see table
+	Positive battery	see table
EV	Electrovalve (on the AC filter)	2.5 mm2
EV	Electrovalve (on the AC filter)	2.5 mm2
A	Remote panel	0.22 mm2
B	Remote panel	0.22 mm2
12	Remote panel	0.50 mm2
-	Remote panel	0.50 mm2

The microswitches allow the direct command of the pump and of the electrovalve. They can be used as an emergency solution for starting the watermaker. They have to be switched off in normal condition. The rated current of the fuse is 400mA.

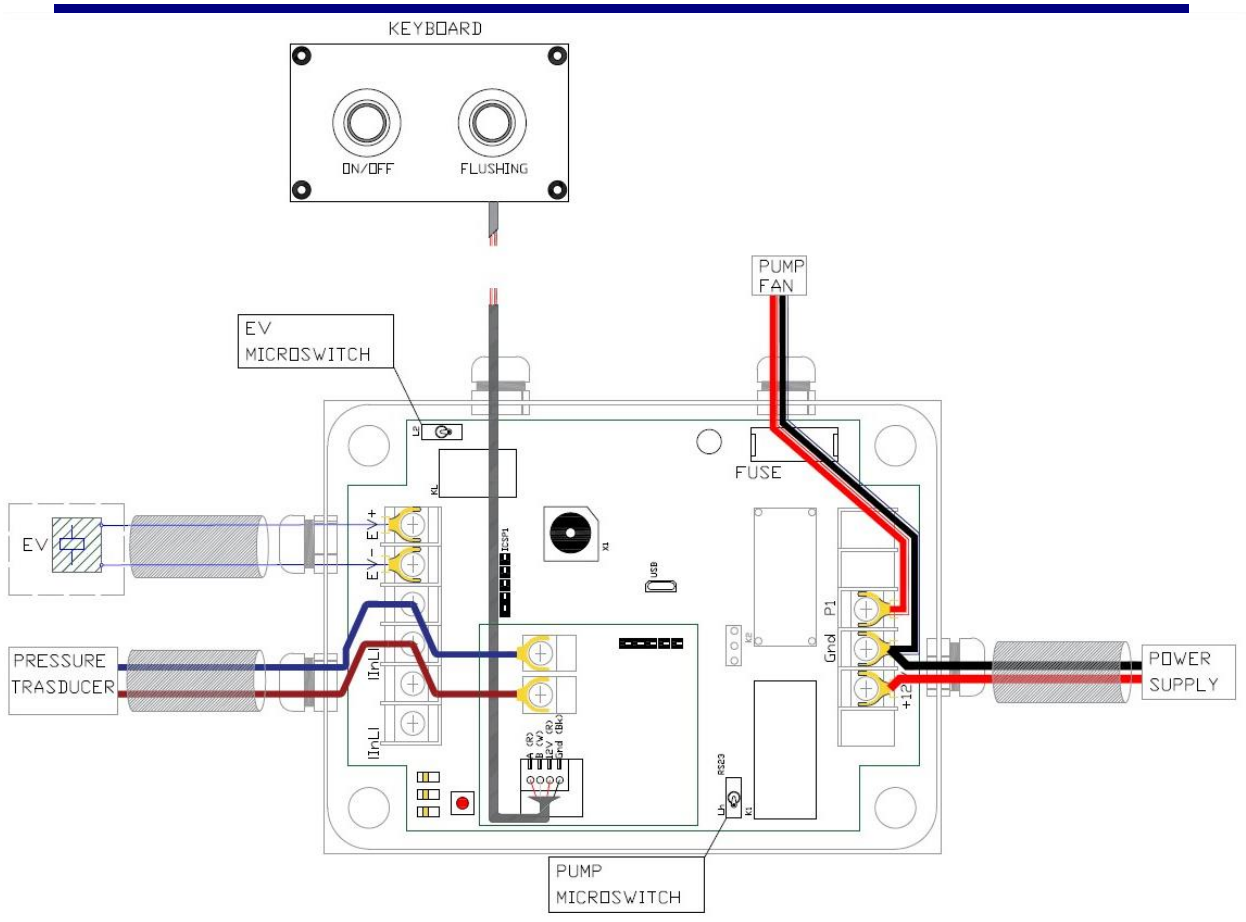

ELECTRIC MAIN BOX SCHEME SMART 30 12/24V DC

FIG. 4-5

5. FUNCTIONING AND USE

5.1 Command description



Remote control panel
Fig. 5.1

KEYBOARD FEATURES

The panel keyboard has a total of 2 push buttons. The functions of the buttons are:

ON/OFF Used to start the pump of the system.

FLUSHING Used to activate the electrovalve and let the system rinse manually with fresh water.

5.1.1 Alarms description

The system has different types of alarm, recognizable by the flashing of the two LEDs on the pushing buttons. If the alarms occur the controller immediately stops the unit:

- **Unit stalled:** the pressure is under the threshold value during the start – the system goes on alert after 5 seconds and the pushing buttons flash 2 times quickly;
- **Underpressure:** the pressure drops under the threshold value during the functioning – the system goes on alert and the pushing buttons flash 3 times quickly.
- **Overpressure:** the pressure raises over the threshold value during the functioning – the system goes immediately on alert and the pushing buttons flash 4 times quickly.
- **Low battery:** power supply is not sufficient - the system goes immediately on alert and the pushing buttons flash 5 times quickly.
- **Control failure:** the pressure transducer is faulty or not properly connected - the system goes immediately on alert and the pushing buttons flash 6 times quickly.

The alarms has to be stopped by pressing the button ON/OFF; then it is necessary to recognize and eliminate the problem before starting again the watermaker.

5.2 First start-up procedure

The first start-up procedure is necessary to start a new plant for the first time or to restart it after having performed the laying up procedure.



The purpose of the star up procedure is to essentially purge the air contained in the system.



5.2.1 Preliminary checks before proceeding with the start-up procedure

Please, be sure to perform all the following checks before proceeding with the start-up procedure:

1. Verify that all plant components are connected correctly.
2. Verify the 5 micron is installed correctly.
3. Be sure the seawater inlet valve and salt water drain valve are opened (If existing).
4. Be sure the reset valve is closed (lever orthogonal to the body valve) and the positioner completely unscrewed.
5. Be sure the fresh water pressurizing pump of the vessel is on.
6. Be sure the grey valve on the active carbon filter is opened.

5.2.2 Start-up

<p>1. Open the depressurization valve (lever horizontal)</p>	
<p>2. Push for 20-30 sec the red button on the active carbon filter housing cup in order to purge the air from the system.</p>	
<p>3. Push Push Flushing for 5 seconds. The panel will beep twice, the button will flash quickly and the procedure will start. The unit can be stopped at any time by pushing the ON/OFF button.</p>	

<p>4. After about 3 minutes the unit will stop itself (the fresh water is now purged from air). Then start the unit again pushing ON/OFF.</p>	
<p>5. After 3-4 minutes close the depressurization valve. The system starts going under pressure and the fresh water production begins. Verify that there are no leaks.</p>	
<p>6. After a while push FLUSHING in order to flush the unit before stopping it. Then the unit will stop after about 1 minute.</p>	

After completed the procedure the system is ready to start normally.

5.3 Normal operating procedure

Preliminary checks:

1. Reset valve closed (lever orthogonal to the body valve) and the positioner completely unscrewed.
2. Depressurization valve closed and grey valve on the active carbon filter open.

5.3.1 Normal operating procedure without final flushing

<ol style="list-style-type: none"> 1. Push ON/OFF to start the watermaker. 2. Push ON/OFF to stop the watermaker. 	
---	--

5.3.2 Normal operating procedure with final flushing (recommended procedure)

<ol style="list-style-type: none"> 1. Push ON/OFF to start the watermaker. 2. Push FLUSHING to flush and stop the watermaker. The watermaker will activate a flushing cycle then it will stop itself after 1 minute. 	 <p>The image shows a black control panel with the Schenker logo at the top. There are two circular buttons: 'ON / OFF' on the left and 'FLUSHING' on the right. A blue arrow points to the 'FLUSHING' button.</p>
--	--

5.3.3 Working cycle with timer

<ol style="list-style-type: none"> 1. Keep ON/OFF pressed for a while, then you will hear 1-2-3-beeps. Once released ON/OFF the watermaker will work for 1-2-3 hours then will flush and will stop. 2. The unit can be stopped at any time by pushing the ON/OFF button (without final flushing) or the FLUSHING button (with final flushing). 	 <p>The image shows a black control panel with the Schenker logo at the top. There are two circular buttons: 'ON / OFF' on the left and 'FLUSHING' on the right. A blue arrow points to the 'ON / OFF' button.</p>
--	---

5.3.4 Long flushing procedure

<ol style="list-style-type: none"> 1. Push FLUSHING. A 3-minute flushing procedure with fresh water will start. Both ON/OFF and FLUSHING buttons' lights will be on. 2. The unit can be stopped at any time by pushing the ON/OFF button 	 <p>The image shows a black control panel with the Schenker logo at the top. There are two circular buttons: 'ON / OFF' on the left and 'FLUSHING' on the right. A blue arrow points to the 'FLUSHING' button.</p>
--	--



CAUTION





If during normal running operation the system detects an irregular condition (high pressure, etc...) the system switches off automatically. Before make the watermaker run again, be sure to individuate the cause of the anomaly and solve the issue.

5.4 Reset procedure

If the watermaker gets air (or if some other problem occurs), the automatic hydraulic valve may stop in a central position. In this case the system has to be manually restarted.

An evidence of this effect is confirmed by a working pressure going up suddenly.

This event, besides being very unusual, does not damage the system, but it is necessary to reset the valve with the following simple procedure:

<ol style="list-style-type: none">1. Turn off the system2. Open the reset valve (lever in horizontal position).	
<ol style="list-style-type: none">3. Open the depressurization valve.	
<ol style="list-style-type: none">4. Screw the positioner knob clockwise until it can be moved no further. Normally 10 turns at least are needed.	
<ol style="list-style-type: none">5. Unscrew the positioner knob counterclockwise up to the original position, until when it is blocked back.	

6. Close the reset valve (lever in vertical position).



7. Restart the system



6. MAINTENANCE (ROUTINE AND SPECIAL)



6.1 Check filter cleanliness

It is very important to inspect filters condition periodically.

The following filters are present in the system:

1. Mesh filter (strainer)
2. Pump filter (5 micron cartridge filter)
3. Active carbon filter

Follow the instructions given in the table below:

OPERATION	FREQUENCY	PROCEDURE
Check and cleaning of the strainer	Every 5 days	<p>Visual inspection and washing</p> 
Replacing of the 5 micron cartridge filters	It depends on the real working condition and the turbidity of the sea water. In average conditions the replacement of the cartridge is recommended every 100-120 working hours. Once replaced the filters it is necessary to purge the air from the system, opening for 2-3 minutes the depressurization valve.	<p>Unscrew the filter housing cup counter clockwise by using the specific key provided</p> 
Replace the active carbon fiber filter	Once per year	<p>Unscrew the filter housing cup counter clockwise by using the specific key provided</p> 

<p>Purge air from the system periodically by opening for 2-3 minutes the depressurization valve at 45°.</p>	<p>Every 15-20 days</p>	
---	-------------------------	--

6.2 Check the plant working pressure

<p>It is necessary to read the pressure on the manometer located on the equipment front panel in order to perform this verification.</p> <p>The working pressure depends on many factors such as water temperature, salinity level of seawater, effective batteries voltage, membranes cleaning degree, typology of installation.</p> <p>The pressure, in normal working conditions, is approx. 7 - 8 Bars. There is a small pressure lost head, in the range of 0,2 bar, during the cycle.</p>	
---	---

If the average pressure exceeds the above ranges it is necessary to check the membranes cleaning degree. It is necessary to perform the shutdown procedure if the membranes result dirty. If cleaning also results insufficient it could be necessary to perform an alkaline washing using the chemical product SCHENKER CLEANING 2 (SC2). It is recommended to contact a Schenker certified service center.

6.3 Check for leaks

It is necessary to perform this verification at every plant start-up and however often, since possible leaks due to accidental causes (hose bursting, hose clamp loosening, equipment failure, etc.) may occur, even plentiful, with the consequence of possible damages.

6.4 Check for membranes replacement

The reverse osmosis membranes have a 7 years average working life. It is recommended therefore, after 5 years of operation, to verify the possible necessity of substitution and however to perform the substitution after 7 years.

6.5 Shutdown procedure

It is necessary to perform the shutdown procedure before standstills longer than 3 months, for instance before the winter laying up.

The purpose of the shutdown is to flush the system from possible organic and inorganic sediments, and inhibit the growth of bacteria that could reduce the reverse osmosis membranes efficiency.

6.5.1 Necessary Equipment

The following equipment is necessary to perform the shutdown operation:

1. 1 tank of fill with at least 15 liters of fresh water.
2. 2 hoses to be connected to:
 - inlet of the pre-pump
 - discharge of the watermaker
3. A bottle of powder **SCHENKER CLEANING 1 (SC1)**. The solution must be prepared following the instruction indicated on the product label, and using chlorine free water (water produced by the system can be an option).
4. Tools for dismounting the system's hoses (screwdrivers, pliers, etc.)

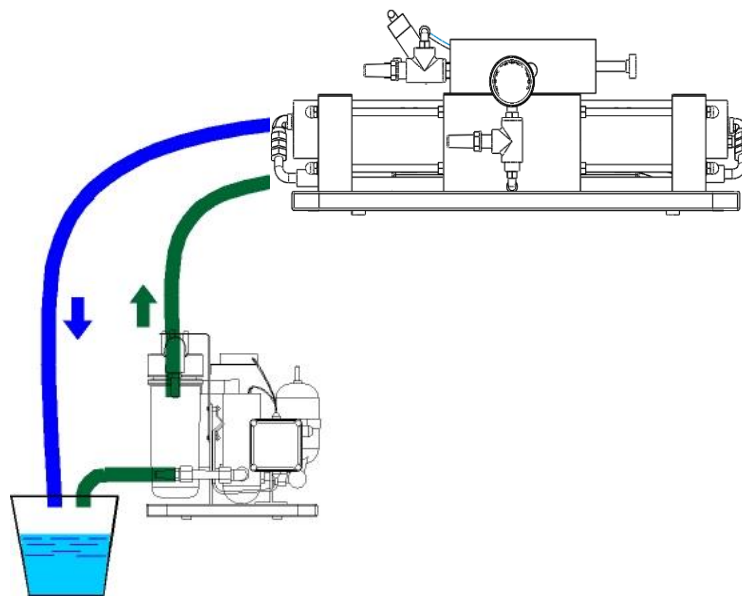

HYDRAULIC SCHEME FOR SHUTDOWN PROCEDURE
FIG. 6-1



NOTE

The available products for the shutdown procedure are the following:

1) SCHENKER CLANING 1 (SC1 – Acid product) to remove the inorganic components and preserve the watermaker during winter break

2) SCHENKER CLEANING 2 (SC2 – Alkaline product) to remove the organic components (mould and bacteria) when already deposited; in this case the system becomes stinky.

Whether the system needs acid or alkaline cleaning will depend on the type of foulant suspected. However, both kinds of cleaning are needed and it is recommended to start with the alkaline cleaning then follow with the acid cleaning after the system has been flushed.





NOTE

Normally only SC1 is required, but in case of strong smell it is recommended to use also the SC2.

The sequence in this case will be SC2 first, then a washing of the system. Finally the SC1, then again washing of the system.

It is advisable to replace the filters after performing shutdown procedure with new ones.

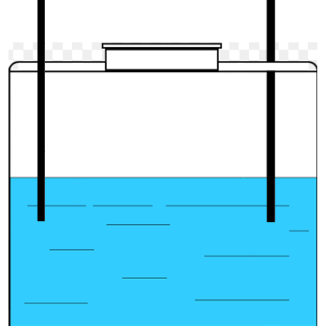
6.5.2 Shutdown operating procedure

<p>1. Prepare the solution carefully mixing the bottle of SC1 in about 15 liters of unchlorinated water.</p>	
<p>2. Connect the 2 hoses to the pre-pump and watermaker as indicated above, and dip them in the solution.</p>	
<p>3. Check they are well dipped in the solution and don't inhale air.</p>	<p style="text-align: center;">Hoses under the free water surface</p> 
<p>4. Open the depressurization valve (turn counter clockwise).</p>	

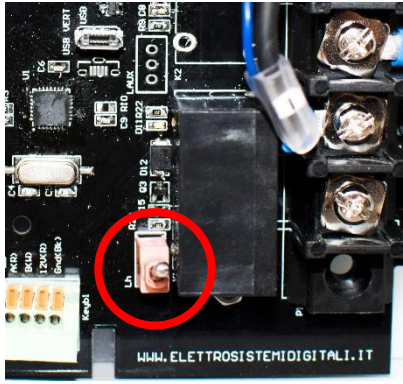
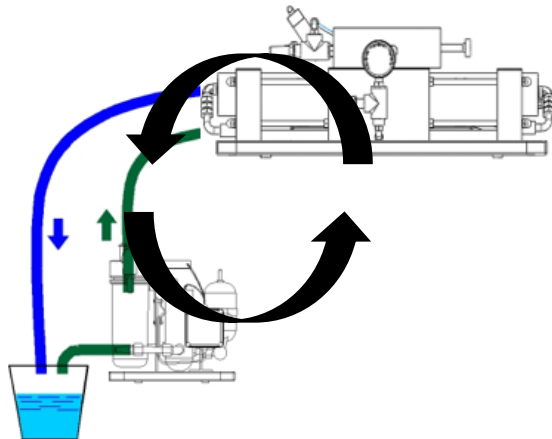
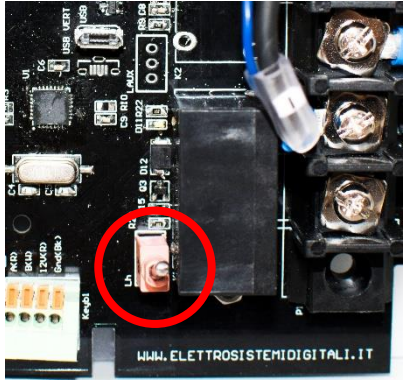
<p>5. Manually start the watermaker through the microswitches inside the pump box (switch down).</p>	 <p>A close-up photograph of a black control board. A small, rectangular microswitch is circled in red. The board has various components, including a USB port, a power jack, and several terminal blocks. The text 'WWW.ELETTROSTEMIDIGITALI.IT' is visible at the bottom of the board.</p>
<p>6. Leave the unit running for approx. 20 minutes, checking that the hoses are properly positioned in the recipient, so that to avoid inhaling air.</p>	 <p>A schematic diagram of the watermaker unit. It shows a pump, a motor, and various hoses. A blue hose is connected to a blue bucket, and a green hose is connected to a green bucket. A large black circular arrow indicates a clockwise cycle of operation.</p>
<p>7. Manually stop the unit through the microswitches inside the pump box (switch up) and connect the original hose.</p>	 <p>A close-up photograph of a black control board, identical to the one in the first row. A small, rectangular microswitch is circled in red. The board has various components, including a USB port, a power jack, and several terminal blocks. The text 'WWW.ELETTROSTEMIDIGITALI.IT' is visible at the bottom of the board.</p>



CAUTION

It is necessary to perform the first start-up procedure when restarting the plant after a shutdown procedure, in order to purge the air and drain out board the chemicals in the systems.

6.6 Antifreeze procedure (Winterizing procedure in cold climate - under 5°C)

It is recommended to first perform the normal shutdown procedure by using SC1 in order to clean the system properly and prevent bacteria growth and inorganic material deposit.

After this operation, Then the system must be flushed and filled with an antifreeze.

The recommended antifreeze product is a solution of **propylene glycol and unchlorinated water**.

The ideal concentration of propylene glycol is

- 45% (for temperatures up to - 20°)
- 55% (for temperatures up to - 30°).



ATTENTION

Do not use ethylene glycol as this substance is toxic and non-degradable.

The total volume of the solution must be about 15 liters.

The procedure is similar to that used for chemical washing with SC1 and SC2 products:

1. Prepare the solution carefully mixing the propylene glycol with 15 liters of unchlorinated water by following the concentration suggested above.
2. Disconnect the drain hose and the pumps suction hose.
3. Connect two hose pieces to the drain and to the pump suction.
4. Insert the end side of the hoses into the bucket, verifying that the hoses have been properly dipped in the solution and that they don't inhale air.
5. Open the depressurization valve.
6. Start the watermaker with the by-pass activated.
7. Leave the unit running for approx. 15/20 minutes, checking that the hoses are properly positioned in the recipient, so that to avoid inhaling air or spilling the liquid into the vessel.
8. Shut the plant off and connect the original hoses taking care of not empty the system during out the solution.

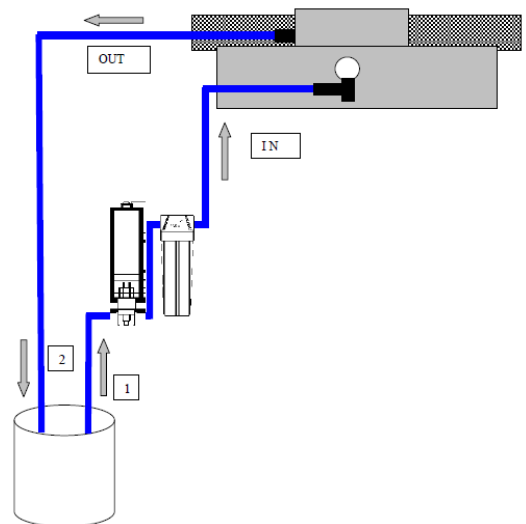

HYDRAULIC SCHEME FOR
WINTERIZING PROCEDURE
FIG. 6-2



ATTENTION

It is necessary to perform the first start-up procedure when restarting the plant after a shutdown procedure, in order to purge the air and drain out board the chemicals in the systems.

Before proceeding with any kind of service it is strongly recommended to read carefully the instruction contained in this manual.

6.7 Periodic maintenance

6.7.1 Membrane replacement

Reverse osmosis membranes have an average lifetime of about 7 years If correctly maintained. It is anyway recommended to check the efficiency of the membranes after 5 years of functioning and verify the needed of a replacement. Please, refer to a certified Schenker service center for this operation.

6.8 Adjustments

Accumulator

It is a reservoir of air that has the function of damping the pressure oscillations during the commutations of the watermaker. The accumulator is factory loaded at a pressure of about 4 bar. The charge level must be periodically checked in order to guarantee a correct functioning to the watermaker.



7. TROUBLESHOOTING

7.1 Troubleshooting chart

Issue	Cause	Remedy
Pump doesn't start	Pump pressure switch disconnected or burned	Restore or replace the pump pressure switch
Pump starts but the system suddenly blocks in high pressure	Hydraulic block Dirty filters Obstruct membranes Commutation system block	Perform reset procedure Replace filters Perform washing procedure Contact a customer service
During operation, the pump temporarily switches off, giving rise to a start and stop phenomenon	Pump pressure switch not correctly set	Set pump pressure switch
	Dirty filters or membranes	Clean or replace
Metal noise of the pump	Pump cavitation	Check the causes of the absence of water flow at the pre-pump inlet
Low production / normal or low pressure	Low battery Air within the system Loss of sealing systems	Check battery charge Purge the air out of the system Contact a customer service
Low production / high pressure (> 9 Bar)	Clogged filters Clogged membranes Cold inlet water	Replace filters Perform washing procedure Contact a customer service
Loss in the system	Loose fittings ERS leaks	Tighten fittings Contact a customer service

8. SUGGESTED SPARE PARTS

8.1 Short term cruising

For short term cruising it is advisable to have onboard a cleaning kit (one SC1 and one SC2 cleaning product) as well as one 5 micron cartridge filter. Other additional spares are listed below with their codes:

Spare part name	Code
SC1 WASHING PRODUCT	SC1
SC2 WASHING PRODUCT	SC2
CLEANING KIT (SC1+SC2)	CK
5 MICRON CARTRIDGE 9 3/4"	F5
ACTIVE CARBON FILTER CARTRIDGE	CA

8.2 Long term cruising

For long term cruising it is advisable to have onboard a cruising kit (three 5 micron cartridge filter, one active carbon filter, one cleaning kit). Other additional spares are listed below with their codes:

Spare part name	Code
SC1 WASHING PRODUCT	SC1
SC2 WASHING PRODUCT	SC2
CRUISING KIT	CRK136
SPARE PUMP SM-MOD 30/60 12V	SP36/12
SPARE PUMP SM-MOD 30/60 24V	SP36/24
MEMBRANE 2521	M2521
PRESSURE TRANSDUCER	DPM
SPARE SEALS KIT 2.0	SS36-2.0

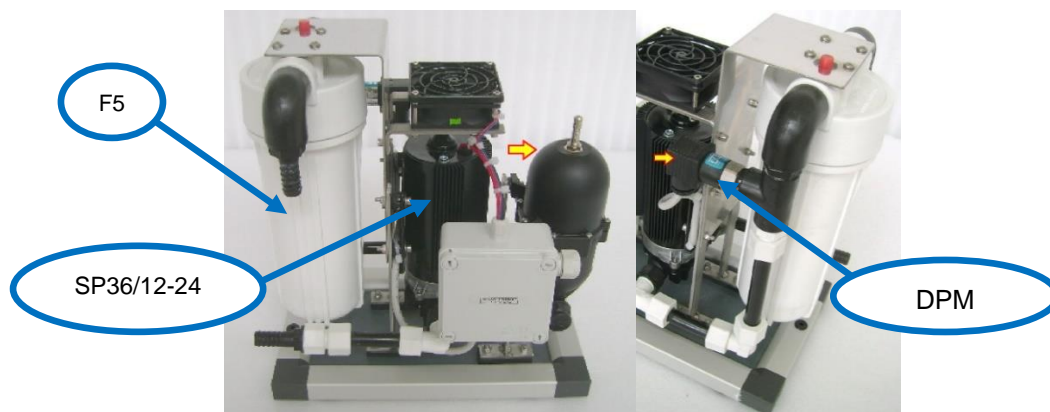

8.3 ERS spare parts

N°	DESCRIPTION	Code
1	CENTRAL SECTION BOTTOM PARTS ERS 30_60_80	CCE368
2	MAIN ROD 30_60_80	MRD36
3	CYLINDER END CUP OPEN 30_60_80	CEC/0368
4	PISTON 30_60_80	PST36
5	CARBON FIBRE CYLINDER 30_60_80	CYL36
6	CARBON FIBRE BOTTOM PIPE 30_60_80	CYC
7	CYLINDER END CUP BLIND 30_60_80	CEC36
8	VALVE ROD	VRD
9	RIGHT VALVE 30_60_80_100	RV
10	LEFT VALVE 30_60_80_100	LV
11	CENTRAL VALVE 30_60_80	CV-S36
12	VALVE PISTONS KIT 30_60_80_100	VPK2.0
13	ERS NON RETURN VALVE KIT 30_60_80	ENRV36

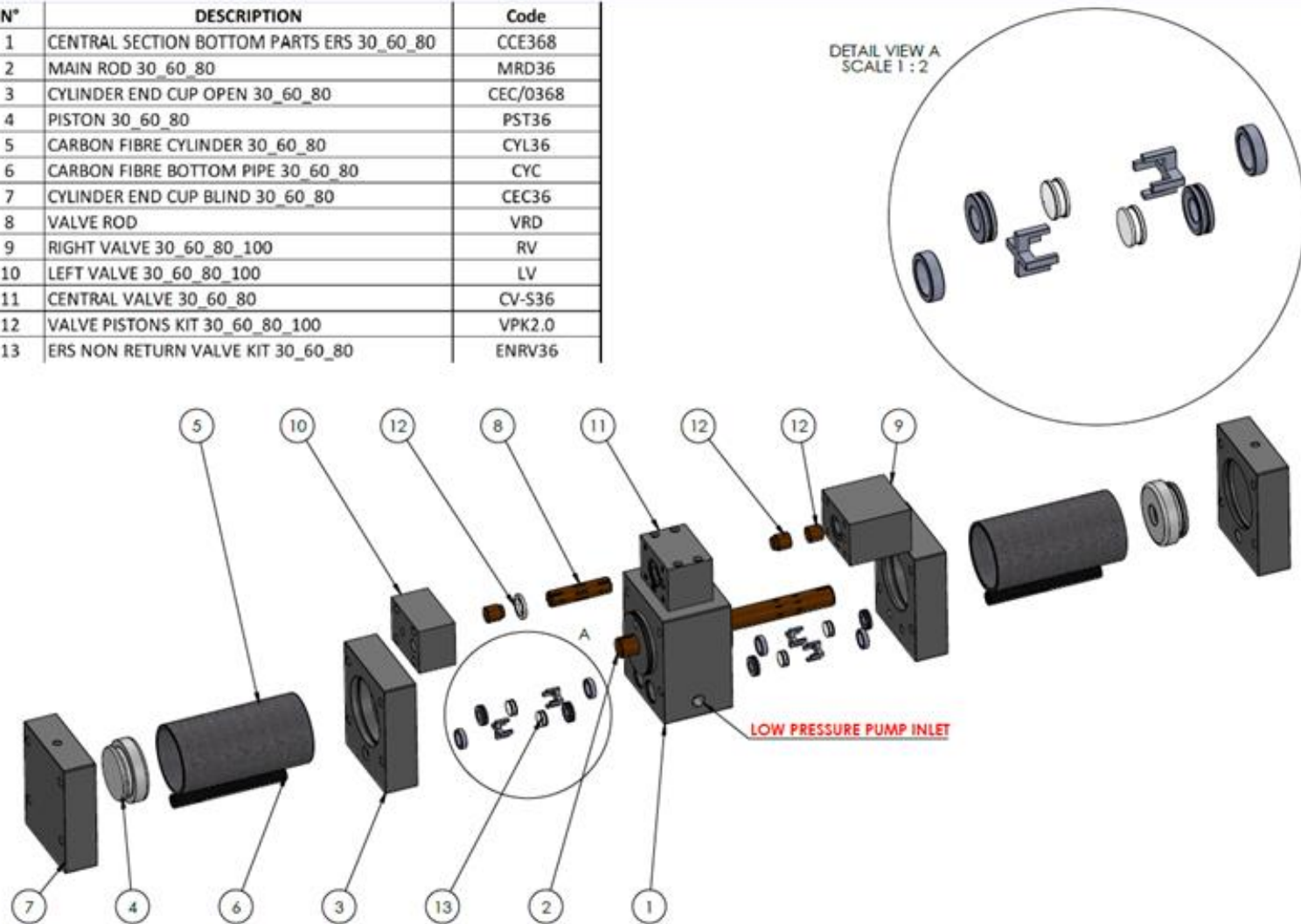

8.4 Additional spares

For extraordinary maintenance intervention that might become necessary in order to ensure the normal operating condition of the watermaker, other common spares are listed below with relative images and codes:

Spare part name	Code
COUPLE HIGH PRESSURE HOSE SM 30/60/80	HPH
END CUP VESSEL 2,5" SINGLE CONNECTION	EV2,5
END CUP VESSEL 2,5" DOUBLE CONNECTION	EV2,5-2
MANOMETERS 0-16	M16B

