

## Installation, use and maintenance manual

**ZEN 50**  
**12/24 V dc**



CE

## INDEX

1. LAYOUT OF MANUAL.....	3
1.1 STRUCTURE OF THE MANUAL .....	3
1.2 DESCRIPTION OF THE SYMBOLS .....	3
2. GENERAL WARNINGS AND INFORMATION TO THE RECIPIENT .....	4
2.1 IMPORTANT INFORMATION .....	4
2.2 SAFETY WARNINGS .....	4
2.3 WARRANTY.....	5
2.4 IDENTIFICATION OF THE UNIT .....	6
2.5 LEGISLATIVE REFERENCE .....	6
2.5.1 DIRECTIVES AND STANDARDS CONCERNING MACHINE SAFETY.....	6
2.5.2 RESPECT FOR THE ENVIRONMENT – REQUIREMENTS FOR REMOVAL AND DISPOSAL.....	6
3. PRESENTATION OF THE PRODUCT .....	8
3.1 TRANSPORT AND MATERIAL HANDLING .....	8
3.2 STOCKAGE .....	9
3.3 PACKAGING.....	9
3.3.1 PACKAGING CONTENTS.....	9
3.4 ATTACHED DOCUMENTS .....	10
3.5 TECHNICAL DATA .....	10
3.6 FEATURES OF THE PRODUCT .....	11
3.7 ADVANTAGES OF THE ENERGY RECOVERY SYSTEM .....	12
3.8 COMPOSITION OF THE MACHINE .....	13
3.8.1 PUMP GROUP.....	13
3.8.2 WATERMAKER GROUP.....	14
3.8.3 ACCESSORIES .....	16
4. INSTALLATION.....	17
4.1 GENERAL CRITERIA .....	17
4.2 COMPONENTS INSTALLATION.....	18
4.2.1 PUMP GROUP.....	18
4.2.2 WATERMAKER GROUP .....	18
4.2.3 ACCESSORIES.....	21
4.3 INSTALLATION .....	21
4.3.1 WATER INTAKE AND DISCHARGE.....	21
4.3.2 SEAWATER INTAKE.....	21
4.3.3 FRESH WATER CONNECTION FOR FLUSHING .....	22
4.3.4 BRINE DISCHARGE .....	22
4.4 HYDRAULIC CONNECTIONS .....	23
4.5 ELECTRIC CONNECTIONS.....	26
4.5.1 REMOTE CONTROL PANEL INSTALLATION .....	26
4.5.2 ELECTRIC CONNECTIONS: WIRES (ZEN 50 12/24V DC) .....	27
5. FUNCTIONING AND USE.....	29
5.1 COMMAND DESCRIPTION.....	29
5.1.1 ALARMS DESCRIPTION .....	29
5.2 FIRST START UP PROCEDURE.....	29
5.2.1 PRELIMINARY CHECKS BEFORE PROCEEDING WITH THE START-UP PROCEDURE .....	30
5.2.2 START-UP.....	30
5.3 NORMAL OPERATING PROCEDURE .....	31

5.3.1	NORMAL OPERATING PROCEDURE WITHOUT FINAL FLUSHING .....	31
5.3.2	NORMAL OPERATING PROCEDURE WITH FINAL FLUSHING (RECOMMENDED PROCEDURE) .....	32
5.3.3	WORKING CYCLE WITH TIMER .....	32
5.3.4	WORKING CYCLE WITH ONE PUMP .....	32
5.3.5	LONG FLUSHING PROCEDURE.....	32
5.4	RESET PROCEDURE .....	33
<b>6.</b>	<b>MAINTENANCE (ROUTINE AND SPECIAL).....</b>	<b>35</b>
6.1	CHECK FILTER CLEANLINESS .....	35
6.2	CHECK THE WATERMAKER WORKING PRESSURE.....	36
6.3	CHECK FOR LEAKS.....	36
6.4	CHECK FOR MEMBRANES REPLACEMENT .....	36
6.5	SHUTDOWN PROCEDURE .....	36
6.5.1	NECESSARY EQUIPMENT .....	37
6.5.2	SHUTDOWN OPERATING PROCEDURE.....	38
6.6	ANTIFREEZE PROCEDURE (WINTERIZING PROCEDURE IN COLD CLIMATE - UNDER 5°C).....	40
6.7	PERIODIC MAINTENANCE.....	41
6.7.1	MEMBRANE REPLACEMENT.....	41
6.8	ADJUSTMENTS .....	41
<b>7.</b>	<b>TROUBLESHOOTING.....</b>	<b>42</b>
7.1	TROUBLESHOOTING CHART.....	42
<b>8.</b>	<b>SUGGESTED SPARE PARTS.....</b>	<b>43</b>
8.1	SHORT TERM CRUISING.....	43
8.2	LONG TERM CRUISING .....	43

## 1. LAYOUT OF MANUAL

### 1.1 Structure of the manual

The manual is divided into chapters, which gather all the information necessary to use the system without risks.

In each chapter there is a subdivision in paragraphs to focus on essential points; each paragraph can be found with a subtitle and a description

Within the chapter, for example chapter 1, we will have:

1	Chapter title
1.1	Paragraph title
1.1.1	Subtitle
1.1.1.1	Further subtitles

The numbering of the figures and tables, is reset to each chapter; therefore, we will find the prefix indicating the chapter and the page number, figure or table in progressive that starts from number 1 at the beginning of each chapter.

### 1.2 Description of the symbols

The following symbols will be used in the manual to highlight important indications and warnings:



**ATTENTION:**

This symbol indicates accident prevention regulations for the operator and / or for any exposed persons.



**CAUTION:**

This symbol indicates that there is the possibility of damaging the system and / or its components.



**NOTE:**

This symbol indicates useful information.

## 2. GENERAL WARNINGS AND INFORMATION TO THE RECIPIENT

### 2.1 Important information

In order to safeguard the operator's safety and avoid possible damages to the machine, before carrying out any operation on the machine, it is essential to read carefully all the instructions.

This manual must be left complete and legible in its entirety, every operator involved in the use of the machine, or responsible for maintenance or adjustment operations, must know its location and must have the possibility to consult it any time.

All rights of reproduction of this manual are reserved to SCHENKER ITALIA. This manual cannot be transferred to third parties without the written authorization of SCHENKER ITALIA.

The text cannot be used in other documents without the written permission of SCHENKER ITALIA.

The descriptions and illustrations provided in this publication are not binding.

SCHENKER ITALIA reserves the right to make any modifications considered appropriate.

© SCHENKER ITALIA

THIS MANUAL IS PROPERTY OF SCHENKER ITALIA, ANY REPRODUCTION, EVEN PARTIAL, IS PROHIBITED.

This manual was drafted according to the requirements of the 2006/42 / EC Machinery Directive.

### 2.2 Safety warnings

- Wear protective equipment suitable for service operation.
- Do not remove safety devices or accident prevention protection.
- Check if the system is properly installed contacting a Schenker service point.
- Verify that the electric and hydraulic connections follow the indicated specifications.
- Avoid using the watermaker if the sea water is polluted.
- Children and inexperienced people shall not touch or use the system.
- Check periodically that no leaks are present. Avoid installing the system where a leak may cause damage and/or jeopardize the safety of the vessel.
- Maintenance should only be carried out by qualified people or Schenker technicians.



## **ATTENTION**

***Any technical changes or operating conditions indicated which affect the correct operation or safety of the machine must only be carried out by the manufacturer's technical staff or by technicians formally authorized by the manufacturer. Otherwise, SCHENKER ITALIA declines any responsibility for changes or damages that may result from it.***

### **2.3 Warranty**

The equipment and the relevant accessories are under 12-month warranty from delivery date. The warranty does not include consumable items (filters, carbon filters, membranes, etc.). The "ERS" pressure amplification device is under 36-month warranty, as long as the watermaker is given a proper maintenance by a specialized Schenker technician. The warranty covers faults due to defected materials and parts. It is limited to the replacement or repair of faulty parts. The charge for the disconnecting and reinstalling on the vessel, as well as the transport from or to our Service Point (or our factory) shall be at the customers own expenses.

The under warranty delivered parts transport shall be at customer's own risk.

In case of repairs under warranty performed by our technicians on the customer's vessel, the faulty parts replacement cost shall be at Schenker's expense, while manpower and travel expenses will be charged on the customer. The warranty does not include faults caused by negligence in operating, maintenance and installation of the device (if not carried out by an authorised Schenker Service point).

Dismantling by non-authorized personnel will invalidate the warranty. Schenker Italia will not be responsible for any direct or indirect damage caused by the malfunctioning equipment, limiting its liability to the repair and replacement of faulty parts.



## **ATTENTION**

***SCHENKER ITALIA declines any responsibility for improper use of the machine, for damages caused as a result of operations not covered by this manual or unreasonable use.***

## 2.4 Identification of the unit

The Zen Watermaker can be identified by a serial number printed on a label on the top valve of the unit.



Serial number  
Fig. 2-1

## 2.5 Legislative reference

### 2.5.1 Directives and standards concerning machine safety

- Machinery Directive 2006/42 / EC, in force since December 29, 2009;
- Low Voltage Directive 73/23 / EEC and subsequent amendments and additions: 93/68 / CEE implemented by the Law of 18 October 1997 n. 791.
- Electromagnetic Compatibility Directive 89/336 / EEC and subsequent amendments and additions: 93/31 / CEE implemented with D.L. December 4, 1992 n. 476.
- Standards UNI EN 292/1 and 292/2 (safety of machinery);

### 2.5.2 Respect for the environment – requirements for removal and disposal



#### **ATTENTION**

***Removal and disposal of materials, as result of the decommissioning of the machine, must be performed in accordance with the regulations in force, for the safeguard and protection of the environment.***

According to removal and disposal, it should be highlighted that the construction materials of the machine are not dangerous for the environment and consist essentially of:

- Stainless Steel;
- Plastic;
- Carbon fibre;
- Motors, cables and consumable electrical materials;
- Rubber and polyurethane seals.

The various materials must be discarded according to the regulations of the country where the machine has been uninstalled.

The machine does not contain dangerous components or substances that require special removal procedures.



**ATTENTION**

***Different legislations are in force in the different countries, therefore the prescriptions imposed by the laws and by the agencies designated by the Countries must be observed.***



## 3. PRESENTATION OF THE PRODUCT



### ATTENTION

**Be sure to follow general safety instructions.**

- Wear protective equipment suitable for the transport and handling operations.
- Lift the machines with equipment appropriate to the weight and size of the box, taking the utmost care and following carefully the instructions on the present use and maintenance manual (attachment points for loading devices, etc.).
- Make sure that the lifting equipment used is in good condition and properly maintained.
- Do not stand under the package during lifting or transport operations.

### 3.1 Transport and material handling

The watermaker unit is transported in a cardboard box. Dimensions and weight are indicated in the following table.



MATERIALS HANDLING  
fig. 3-1

	Model	L cm.	W cm.	H cm.	Weight Kg.
	Zen 50	82	49	50	45

Packaging dimensions and weight  
tab.3-1

## 3.2 Stockage



### ATTENTION

To avoid damage to the system, be sure to keep the unit in a dry place with a temperature between 5°C and 35°C. Very cold temperatures could lead to a freezing of the fluid inside the system and, as a clear consequence, a permanent damage of the latter.

## 3.3 Packaging

### 3.3.1 Packaging contents



PACKAGING  
FIG. 3-2

ZEN 50	
Watermaker	Pump group
Active carbon filter with electrovalve	5 microns filter with accumulator
Mesh filter	Non-return valve with Tee fitting
Remote panel	10 mt extension cable for remote panel
Installation kit	Filter key
6x8 hose for production	

### 3.4 Attached documents

The package contains the technical documentation (use and maintenance manual, electric and hydraulic scheme, warnings and instructions).



#### ATTENTION

- Read carefully the use and maintenance manual before installing the system.
- Use only recommended material for the installation (especially hoses, fittings and seals) in accordance with the manual.
- Do not store the unit under temperature below 5°C and above 35 °C



DOCUMENTS INCLUDED IN THE PACKAGING  
FIG. 3-3

### 3.5 Technical data

#### WATERMAKER

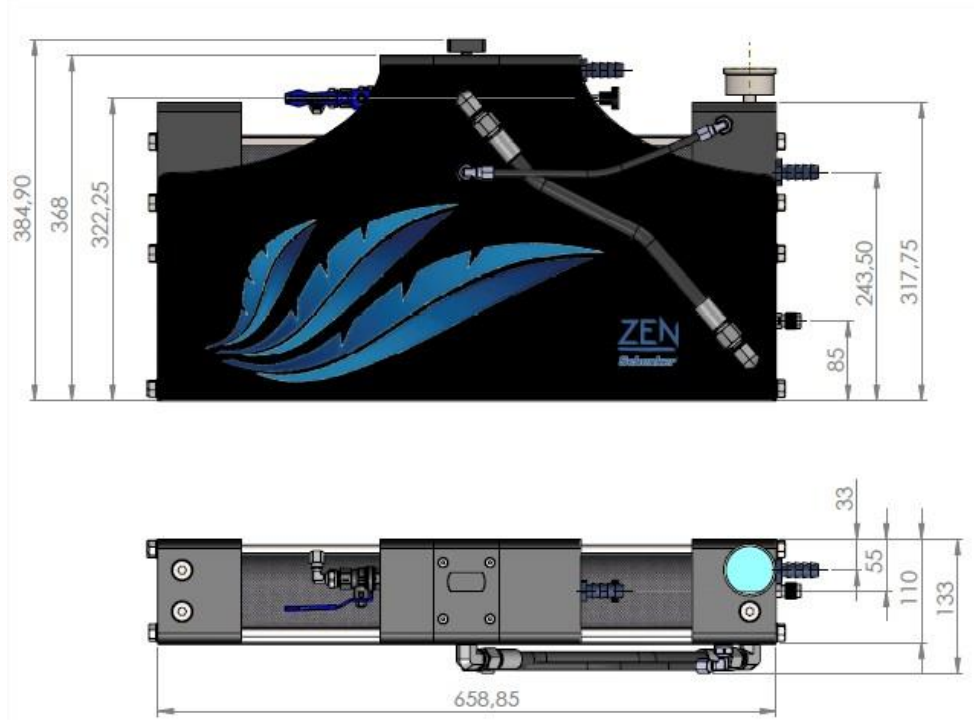

WATERMAKER DIMENSIONS  
FIG. 3-4

### *Hydraulic Connection*

Seawater inlet: hose barb for 16mm internal diameter reinforced hose.  
Brine Discharge: hose barb for 16mm internal diameter reinforced hose.  
Fresh water: ¼" fitting, 6x8mm hose.

### **PUMP**

#### *Dimensions*

Length: 44 cm  
Width: 23 cm  
Height: 29 cm  
Weight: 10 Kg

### *Hydraulic Connection*

Water inlet: hose barb for 16mm internal diameter reinforced hose.  
Water outlet: hose barb for 16mm internal diameter reinforced hose.

**Feed pump type:** Shurflo diaphragm pump

**Filters:** n. 1 Cartridge filter 5 microns 2.32" x 9 ¾"  
n. 1 Active carbon filter 2.32" x 9 ¾"

**Power supply:** 12 VDC +/- 15% (50Z12 version)  
24 VDC +/- 15% (50Z24 version)

**Average electric consumption:** 250 Watt/h average

**Nominal fresh water production:** 50 Lit/h +/- 20% @ seawater 25 °C salinity 35.000 ppm

**CEE conformity:** In compliance with directives 89/392 CEE sect.1 (general safety machines requirements), 89/336 CEE (electromagnetic compatibility), 73/23 CEE (electric safety requirements)

### **3.6 Features of the product**

The fresh water produced by a Schenker watermaker, obtained by clean seawater, has a high purity. Despite this, the potability may not be guaranteed: bacterium caused by non-observance of shutdown and cleaning procedures may be present in the watermaker. Therefore, it is essential that the correct shut down and storage procedures are followed to ensure continued purity of the fresh water. UV treatment of the fresh water may well be beneficial.

### 3.7 Advantages of the Energy recovery system

#### Introduction

Thank you for choosing a Schenker Watermaker.

The knowledge of operating and maintenance procedures allows to use the system in the best way, and to guarantee a perfect functioning throughout the years. We invite you to read carefully this manual and to keep it for a quick reference.

#### Functioning principles

The Schenker watermakers, as an alternative to the high-pressure pumps of traditional systems, use the ENERGY RECOVERY SYSTEM patented device, which amplifies the pressure of common low-pressure pumps, and recover all the hydraulic energy back from the membranes, allowing a high energy efficiency.

The lack of high-pressure pumps makes the system silent and vibration-free and enormously simplifies its use since no adjustment is necessary for its operating.

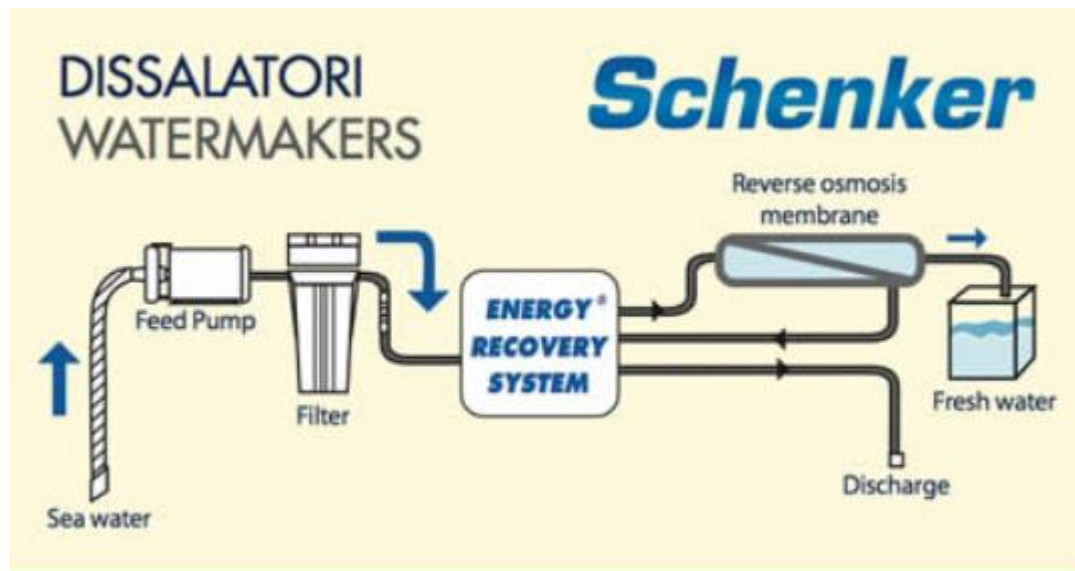

FUNCTIONING SCHEME  
FIG. 3-5

### 3.8 Composition of the machine

The machine is composed of the following parts:

1. PUMP GROUP
2. WATERMAKER GROUP

#### 3.8.1 Pump group

This pump draws sea water and sends it to the watermaker group, through the pre-filter. The pump group is composed of the following components:

- 5 micron cartridge filter
- Diaphragm pump
- Pressure transducer
- Pump box
- Accumulator

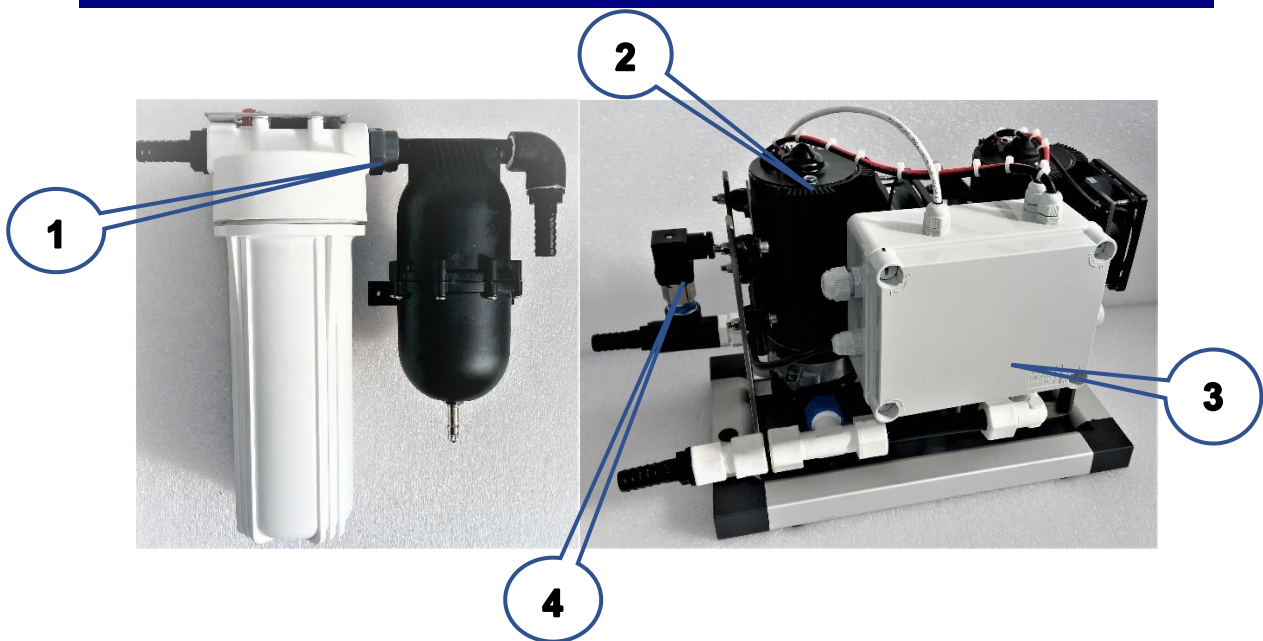

PUMP GROUP AND FILTER 12-24 V DC  
FIG. 3-6

- |  |                            |
|--|----------------------------|
| ① 5 micron cartridge filter with accumulator | ③ Pump box with controller |
| ② Diaphragm pumps                            | ④ Pressure transducer      |



## 3.8.2 Watermaker group

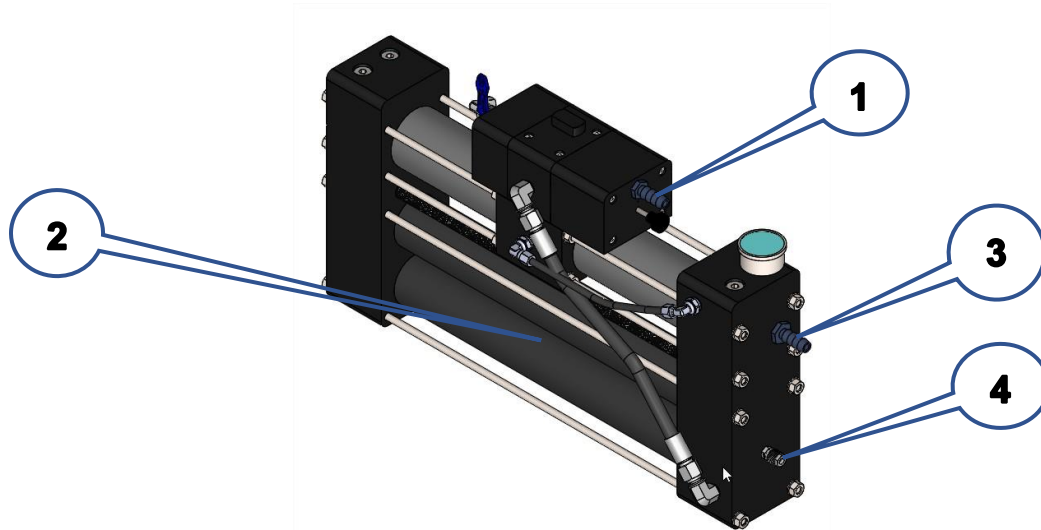

WATERMAKER GROUP (SIDE VIEW W/O COVER)  
FIG. 3-7

- |                               |                          |
|-------------------------------|--------------------------|
| ① Watermaker outlet/discharge | ③ Watermaker inlet       |
| ② Reverse osmosis membranes   | ④ Fresh water production |

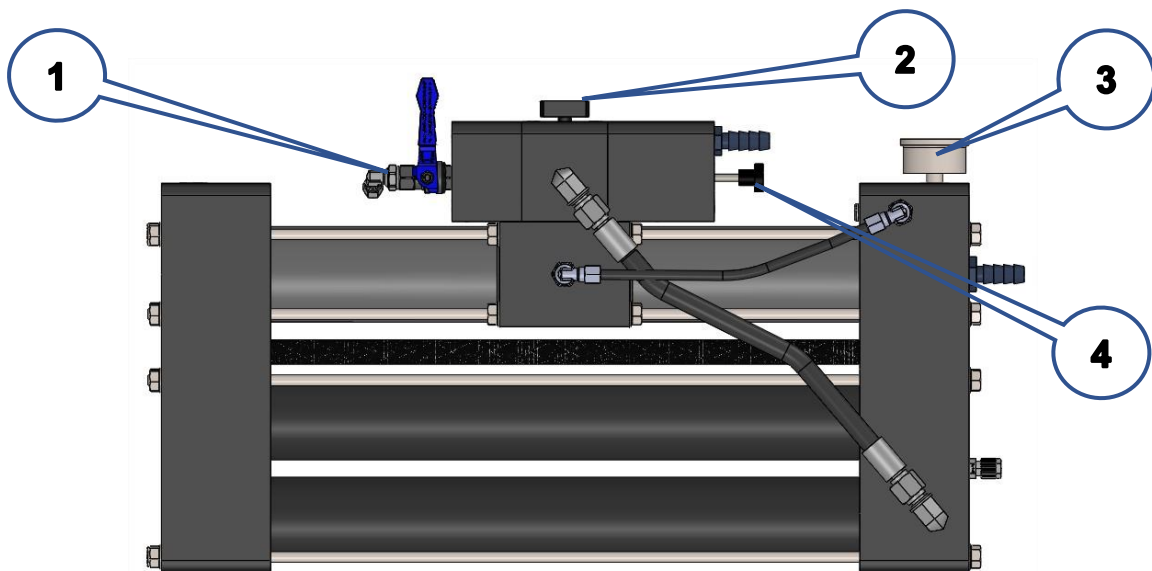

WATERMAKER GROUP (FRONT VIEW W/O COVER)  
FIG. 3-8

- |                          |                   |
|--------------------------|-------------------|
| ① Reset valve            | ③ Manometer       |
| ② Depressurization valve | ④ Positioner knob |

The watermaker group is composed of the following parts:

- Reverse osmosis membranes
- Energy Recovery System
- Manometer
- Accumulator
- Depressurization valve
- Positioner
- Reset valve
- Pressure transducer

**Reverse osmosis membranes.** They are installed inside the carbon fibre high-pressure housing. Membranes are n.2 x SW2521 type. Their purpose is to separate the intake high-pressure seawater in two flows: one for the salt-water drain and one for the fresh water production.

**Energy Recovery System.** The heart of the system. It has the function of amplifying the pressure supplied by the pumps and to recoup the hydraulic energy back from the membranes. The ERS device makes periodic cycling by a hydraulically controlled automatic valve. The cycles are noticeable through a "beat" issued by the watermaker unit. The unit is based on cylinders and a central body containing the hydraulic valve necessary for the system to function.

**Manometer.** Located on the right side of the watermaker, it measures the working pressure of the watermaker.

**Accumulator.** This is an air accumulator installed after the cartridge filter group. Its function is to reduce and stabilize the pressure peaks during the functioning of the watermaker. The device has to be pre-charged with air through the Schrader valve. The pressure is about 4 Bar. The accumulator is already pre-charged to the correct pressure.

**Depressurization valve.** It is used for the air bleeding of the unit. It is located on the top of the watermaker. Its function is to depressurize the system and to allow the bleeding of air. The valve must be closed during normal working conditions (completely screwed in) and it is opened during the air bleeding operations (slightly unscrewed).

**Positioner.** It is a stainless steel threaded shaft, with a black knob, located on the right hand side of the watermaker. Its function is to reset the unit in case of hydraulic block.

**Reset valve.** It is installed on top of the ERS. It is recognizable by the little blue lever. The valve must be closed during normal functioning (lever perpendicular to the valve). This valve has the function of allowing the resetting of the ERS in case of a system block. It must be opened before screwing in the valve positioner.

**Pressure transducer.** It is hydraulically connected to the pump group. It stops the system if the pump pressure exceeds 9,5 bar or if it doesn't reach 0,8 bar.



### 3.8.3 Accessories

The main accessories of the watermaker are the following:

- Active carbon filter
- Electrovalve (or solenoid valve)
- Non-return valve (or check valve)
- Mesh filter (strainer)

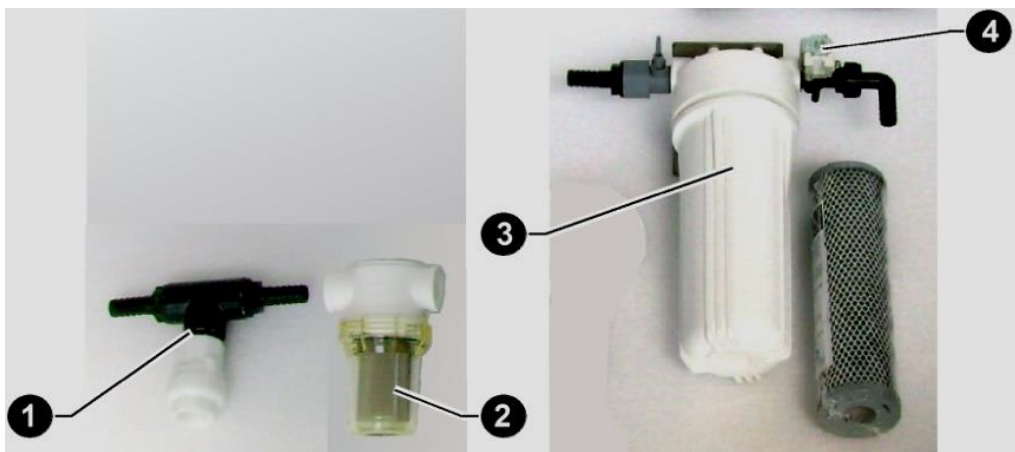

ACCESSORIES  
FIG. 3-9

- ① Non-return valve
- ② Mesh filter

- ③ Active carbon filter
- ④ Electrovalve

**Active carbon filter.** This filter is connected between the fresh water pressurized system of the boat and the electro valve on the filter holder. A manual valve positioned on the filter inlet allows replacement of the cartridge without depressurizing the fresh water system of the vessel.

**Electrovalve (or solenoid valve).** It has the function of switching from seawater intake to fresh water tank when washing the watermaker.

**Non-return valve (or check valve).** It stops water flowing out of the inlet hose. It must be installed vertically. It stops leaking of fresh water from the seacock while the washing procedure starts.

**Mesh filter.** The machine is equipped with a strainer to protect the pump from macro sediments. This is placed between the seacock and the pump.

## 4. INSTALLATION

### 4.1 General criteria

Before starting the installation, it is important to carefully plan all the activities, by evaluating all the siting locations of the equipment. The main points to focus on are the followings:

- Selecting of seawater inlet/outlet
- Positioning of the main units (pump group, watermaker group, active carbon filter).
- Positioning of the thermal-magnetic circuit breaker.
- Routing of the hoses and electric cables.



#### **CAUTION**

*For a correct installation of the watermaker please follow the instructions below:*

- *The through-hull fitting should be located in a central and low position on the hull, so that air can't be drawn into the pump and subsequently into the watermaker itself.*
- *The non-return valve has to be installed under seawater level and as close as possible to the through-hull fitting, in vertical position.*
- *The pump must be installed as low as possible in respect of the waterline and as close as possible to the seawater intake (through-hull fitting). No more that 2m away unless a positive feed is achieved by locating the pump below the waterline.*
- *The watermaker unit must be positioned and arranged on an adequate support which is able to sustain the weight (about 25 kg). The max allowed room temperature where the watermaker is installed must not exceed 40°C*



#### **CAUTION**

*The pump group must be installed in a ventilated place, in order to facilitate the cooling of the electric motor.*



#### **ATTENTION**

*The external surface of motor of the pump can reach high temperatures; therefore, it is recommended to avoid possible contacts with inflammable liquids and materials.*



#### **NOTE**

*Once an installation plan has been made, it is recommended to make a schematic drawing of the hydraulic and electric connections and attach them to the manual for future reference.*

## 4.2 Components installation

### 4.2.1 Pump group

The pump group must be installed as close as possible to the waterline as (maximum no more than 600mm above) and as close as possible to the water inlet (2m max). Therefore, it is very important to avoid starting the system if the intake valve is closed or if inlet filters are clogged.

The pump group should be installed in a ventilated area, with the purpose of aiding the cooling of the motor. **The max allowed room temperature must not exceed 40°C.**

Avoid the contact or the proximity with inflammable material or liquid, since the motor surfaces can reach elevated temperatures. Avoid locating the pump wherever a possible loss of water can involve damages or jeopardize its safety. The pump group must be installed on a base sufficiently horizontal, suitable to sustain the weight of the group. The pump group is normally fixed on the support structure by passing bolts.

### 4.2.2 Watermaker group

Install the watermaker above the pump. **The max allowed room temperature where the watermaker is installed must not exceed 40°C.** It can be placed either horizontally or vertically. **The watermaker must lie completely on a flat surface. The supplied neoprene-based adhesive must absolutely be stuck to the supporting surface, cutting it in such a way to cover as much as possible of the surface.** Once in place on the supporting surface, the watermaker must be fastened with the provided L-brackets and the rubber nubs. **In no way must the watermaker be suspended using solely the L-brackets but it must rest on a flat surface at all times. Otherwise a shelf is necessary as base to support the weight of the watermaker.** The brackets are colour-coded according to their position.

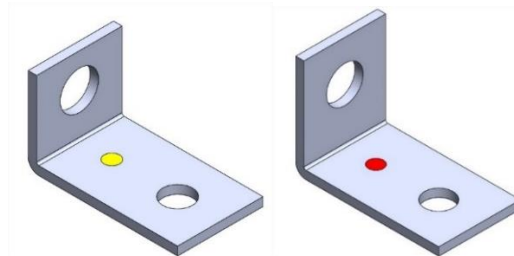

L BRACKETS  
FIG. 4-1

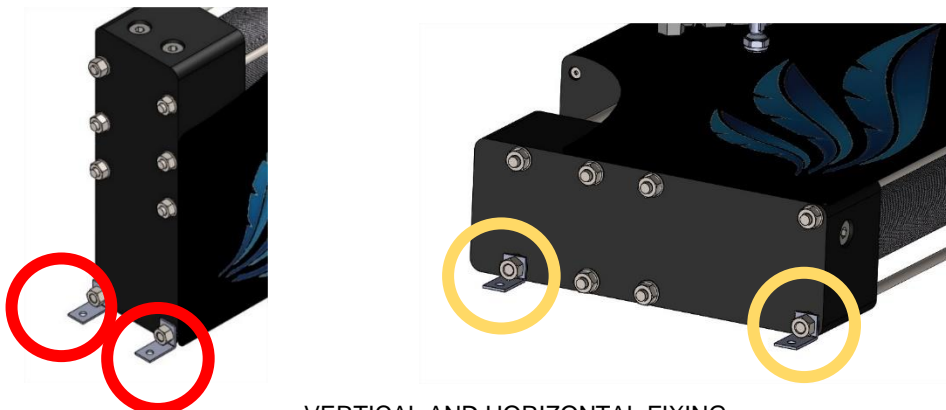

VERTICAL AND HORIZONTAL FIXING  
FIG. 4-2

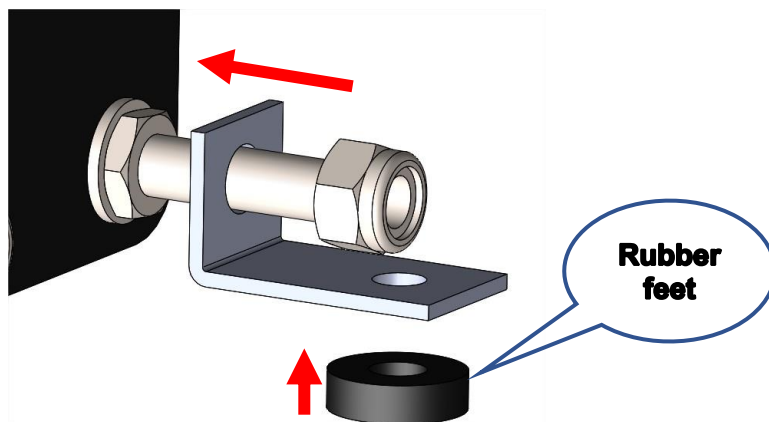

INSTALLING PROCEDURE  
FIG. 4-3

ok

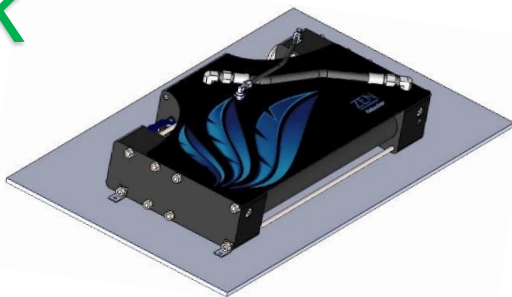

ok

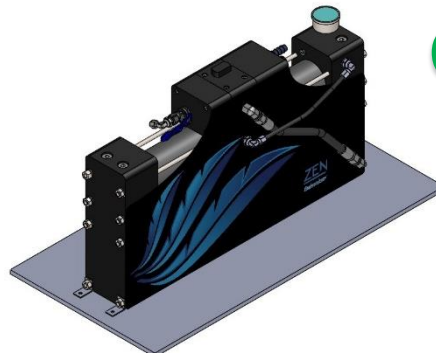

NO

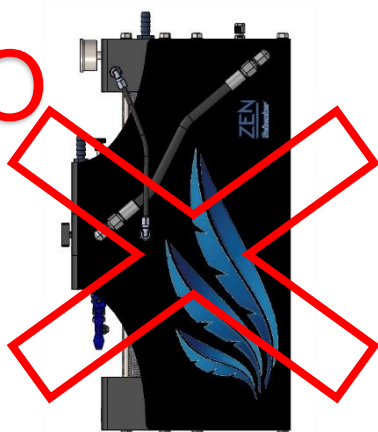

NO

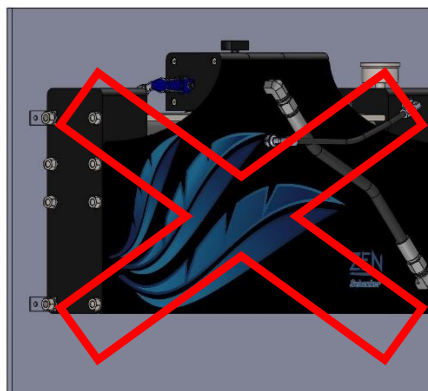

POSSIBLE CONFIGURATIONS  
FIG. 4-4

For a complete installation, antivibration rubber stickers are provided.

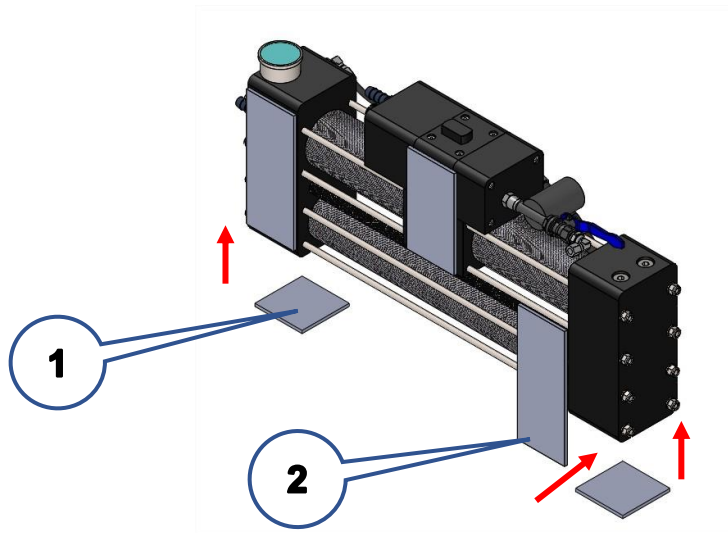

RUBBER STICKER POSITIONS  
FIG. 4-5

❶ Vertical installation

❷ Horizontal installation



**ATTENTION**

*Please follow the instruction to install the unit: an incorrect installation could damage the lateral manifolds of the watermaker.*

If the unit is installed horizontally, it is recommended to connect the manometer horizontally in order to be visible. This can be done by making use of the fittings provided.

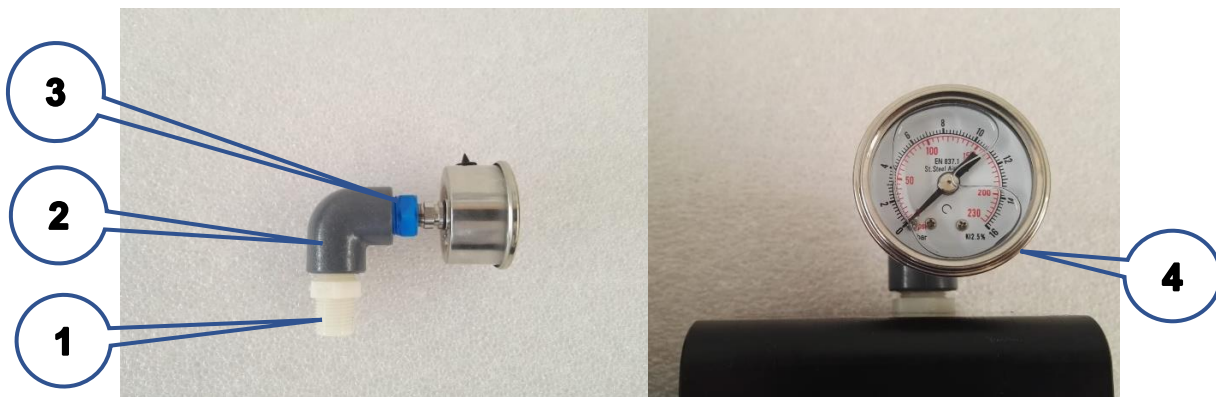

HORIZONTAL FIXING  
FIG. 4-6

❶ 3/8" Nipple

❷ 3/8" 90°-Degree Elbow

❸ 3/8" male to 1/8" female reducer

❹ Manometer

There is a plug on the right side of the watermaker (1). This plug has to be removed with a key #27 and has to be replaced with a housebarb (2), provided with the installation kit. It could be installed with a key #22 until its mechanical stop. Don't exceed with the torque.

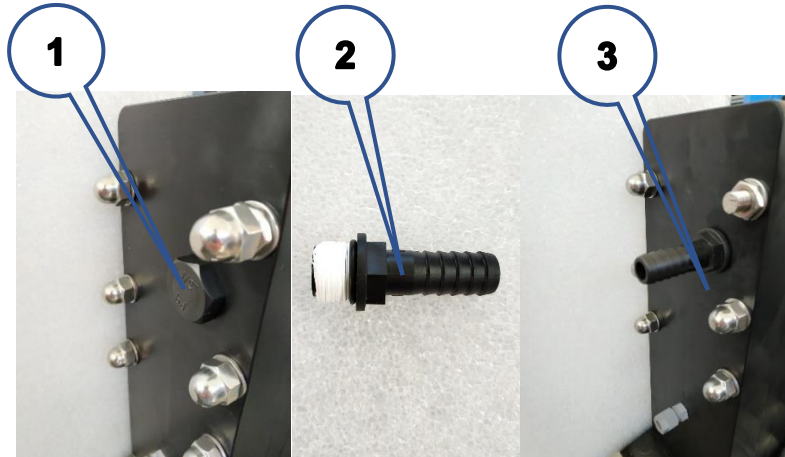

SEAWATER IN MOUNTING  
FIG. 4-7

- ❶ Plug
- ❷ IN housebarb
- ❸ Final installation

### 4.2.3 Accessories

The non-return valve has to be installed vertically as close as possible to the seawater intake, following the direction of the arrow.

The active carbon filter (and the attached electrovalve) has to be placed next to the pump group, if possible, vertically and easily accessible.

## 4.3 Installation

### 4.3.1 Water intake and discharge

For a correct installation of the watermaker, it is necessary to arrange the following water intake and discharge out of the board:

- Seawater intake.
- Fresh water intake for washing.
- Brine discharge.

### 4.3.2 Seawater intake

<p><b>Seacock with through-hull fitting</b></p>	<p>The ideal seawater intake should be 3/4" minimum and located in a central position, well under the waterline even when the vessel is well heeled over. A scoop skin fitting is recommended. It must be oriented to the bow of the boat.</p> <p>In case of powerboats with a cruising speed above 15 knot, it is advised to make a small hole (8 mm. diameter) on the back of the shape, in order to reduce dynamic prevalence during navigation.</p>	<p>Size 3/4"</p>
---	---	------------------

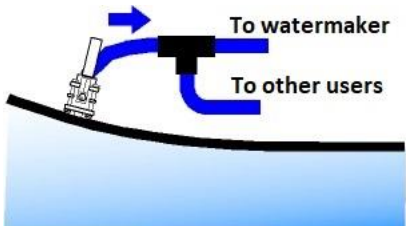

<p><b>Pre-existing seacock adapting (alternatively)</b></p>	<p>As alternative, it is possible to use a Tee fitting into a pre-existent water inlet as long as the following conditions are satisfied:          3/4" minimum size.          The fitting must be located both low and central in the hull and not forward of the keel.          No air can be introduced into the system from other use ie: salt water taps in galley.          Must always be under the water surface even when the vessel is well heeled over.          Must be far from WC discharge.</p> <p> <b>CAUTION</b>  <i>Do not use the pre-existing water inlet of the cooling system dedicated to the motor.</i></p>	<p style="text-align: right;">Size 3/4"</p> 
---	--	---



**INSTALLATION NOTES**

- The hose connections, especially if under the seawater level, must be secured with double hose clamps.
- An easily inspected mesh type filter will be required close to the water intake. The filter has to be of 50 Mesh. It is possible to use filters from existing outlets.
- The seawater intake must be at least 3/4" size.



**INSTALLATION NOTES**

*The strainer has to be connected close to the through-hull, and must be easily accessible for inspection.*

**4.3.3 Fresh water connection for flushing**

<p><b>Fresh water connection for flushing</b></p>	<p>It is necessary to use a tee fitting downstream the fresh water pressure pump of the boat.          The following conditions must be respected:</p> <ul style="list-style-type: none"> <li>• The flow of the fresh water pump must be <b>min 10 lit/min at 1 bar.</b></li> <li>• Flushing must always be performed with the fresh water pump ON.</li> </ul>	<p><b><i>Fresh water pump of the boat:          Min. flow rate 10 lit/min. at 1 bar.</i></b></p>
---	--	--

**4.3.4 Brine discharge**

<p><b>Discharge connection</b></p>	<p>The discharge connection (back to the sea) has to be possibly above the sea level. Minimum size 1/2" BSP</p>	<p><b>Minimum size 1/2" BSP</b></p>
	<p>It is possible to use a tee fitting on existing discharge hoses (ie: tap discharges) provided that there are no returns of dirty water back to the watermaker.</p>	

## 4.4 Hydraulic connections

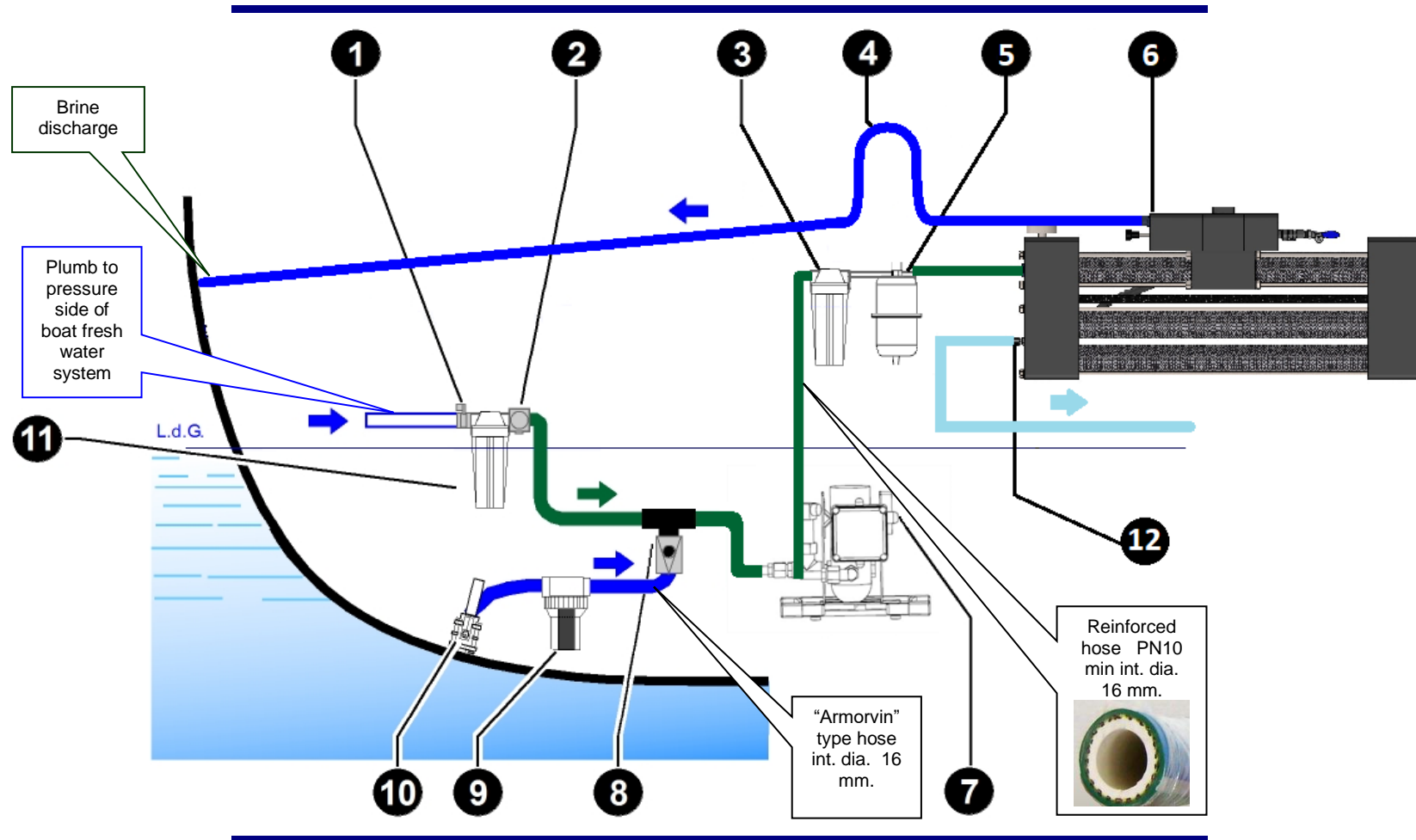

HYDRAULIC CONNECTION AND PIPES  
FIG. 4-8



- |                                 |                                  |
|---------------------------------|----------------------------------|
| ① Pressurized fresh water valve | ⑦ Pump                           |
| ② Electrovalve (solenoid valve) | ⑧ Non return valve (check valve) |
| ③ 5 micron filter               | ⑨ Mesh filter                    |
| ④ Swan neck upward - Discharge  | ⑩ Water inlet                    |
| ⑤ Accumulator                   | ⑪ Active carbon filter           |
| ⑥ Watermaker                    | ⑫ Fresh water outlet             |

All the hydraulic connections (with exception of the fresh water production) have to be made with 16 mm. int. diam. hose. The hydraulic section under consistent pressure is the pump outlet – 5 m. filter – watermaker inlet. For this section is necessary to use a good quality **PN 10 min.** reinforced hose. An inadequate hose could burst, seriously jeopardizing the safety of the vessel.

The hydraulic connections are:

<b>Low pressure connections – max 3 bar</b>	<ul style="list-style-type: none"> <li>• Connection between seawater intake –mesh filter – non-return valve inlet – pump group</li> </ul>	<b>Armorvin reinforced pipe PN 6 with 16mm internal diameter</b>
	<ul style="list-style-type: none"> <li>• Connection between the discharge of the watermaker – through hull discharge fittings of the vessel</li> </ul>	<b>Armorvin reinforced pipe PN6 with 16mm internal diameter</b>
<b>Medium pressure connections – max 10 bar</b>	<ul style="list-style-type: none"> <li>• Connections fresh water pressurized system– carbon filter-backflow valve outlet–pump inlet</li> <li>• Connections pump outlet-5 microns filter– watermaker inlet.</li> </ul>	<b>Rubber reinforced pipe PN 10 minimum, 16 mm internal diameter.</b>
<b>Low pressure connections – max 3 bar</b>	<ul style="list-style-type: none"> <li>• Watermaker - fresh water tank</li> </ul>	<b>¼” fittings, Small plastic blue pipe 6x8mm provided within the scope of supply</b>



## PUMP CONNECTIONS:

Connect the in/out hoses to the pump as follows:

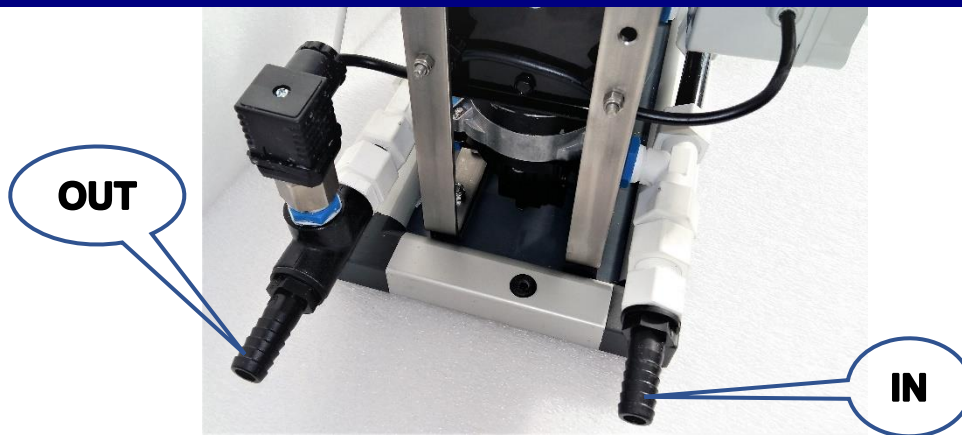

PUMP IN AND OUT  
FIG. 4-9



### CAUTION

*The pump has to be placed as close as possible to the seawater intake and as low as possible to the seawater line; furthermore, it is recommended to avoid long and convoluted path of the connection hoses.*



### ATTENTION

*The use of improper hoses can cause them to burst which endangers the security of the vessel.*

## WATERMAKER CONNECTIONS:

### WATERMAKER INLET (Sea water inlet from the pump):

Make use of the holder located on the right side of the watermaker (marked **IN**).

### WATERMAKER OUTLET (Discharge outboard):

Make use, for this connection, of the holder located on right side of the unit (marked **OUT**). Create a Swan neck upward, when the drain outlet on the vessel is positioned below the watermaker unit, in order to guarantee a water head.

### PRODUCTION FRESH WATER CONNECTION

The connection has to be made using the small hose supplied with the equipment. The connection has to be made between the polyethylene pipe that comes out the watermaker unit (on the right), and the upper side of the tank, on a 1/4" outlet if available.

It is possible, in case of metal tanks, to make a 1/4" threaded hole to connect the supplied male connector. Another option is to Tee into the tank air vent hose. There are no particular limits on the connection length.

## 4.5 Electric connections



### ATTENTION

*These steps have to be performed by a qualified technician/operator, by referring to the electrical drawings provided in this document.*

### 4.5.1 Remote control panel installation

The remote control panel has the following dimensions:

*width 100 mm. height 66 mm.*

It can be fixed on any internal boat panel, provided that the area behind is free of moisture and condensation and there is enough depth to house the rear part of the panel (approx. 50 mm.).

The cut to be performed on the boat covering panel, to encase the remote control panel, has the following dimensions:

*width 80 mm. height 50 mm.*

The remote control panel can be connected through the pre-wired multiple cable of a 10mt standard length provided. It is possible to request to the factory a longer cable if necessary.



REMOTE CONTROL PANEL  
FIG. 4-10

---

## 4.5.2 Electric connections: wires (ZEN 50 12/24V DC)

The 12/24 V power supply, from the service batteries, must be connected to the +/- clamps on the card of the computer box. A 32 Ampere automatic circuit breaker for 12V systems must be installed on the power supply, while a 16 Ampere for 24V systems.

The connection must be suitable to take the typical electric load (250Watt continuous).

The power supply cable section is related to the length of the cable. See the diagram of the recommended sections below.

Voltage	Automatic switch	Cable lenght					
		up to 3 mts		3 - 7 mt.		7-10 mt.	
Volt	Ampere	mm2	AWG	mm2	AWG	mm2	AWG
12	32	10	7	16	5	25	3
24	16	4	11	4	11	6	9

### The connection diagram in the computer box is the following:

<i>Clamp</i>	<i>connect to</i>	<i>cable section</i>
-	Negative battery	see table
+	Positive battery	see table
EV	Electrovalve (on the AC filter)	2.5 mm2
EV	Electrovalve (on the AC filter)	2.5 mm2
A	Remote panel	0.22 mm2
B	Remote panel	0.22 mm2
12	Remote panel	0.50 mm2
-	Remote panel	0.50 mm2

The microswitches allow the direct command of the pumps and of the electrovalve. They can be used as an emergency solution for activating the watermaker. They have to be switched off in normal condition. The rated current of the fuse is 400mA.

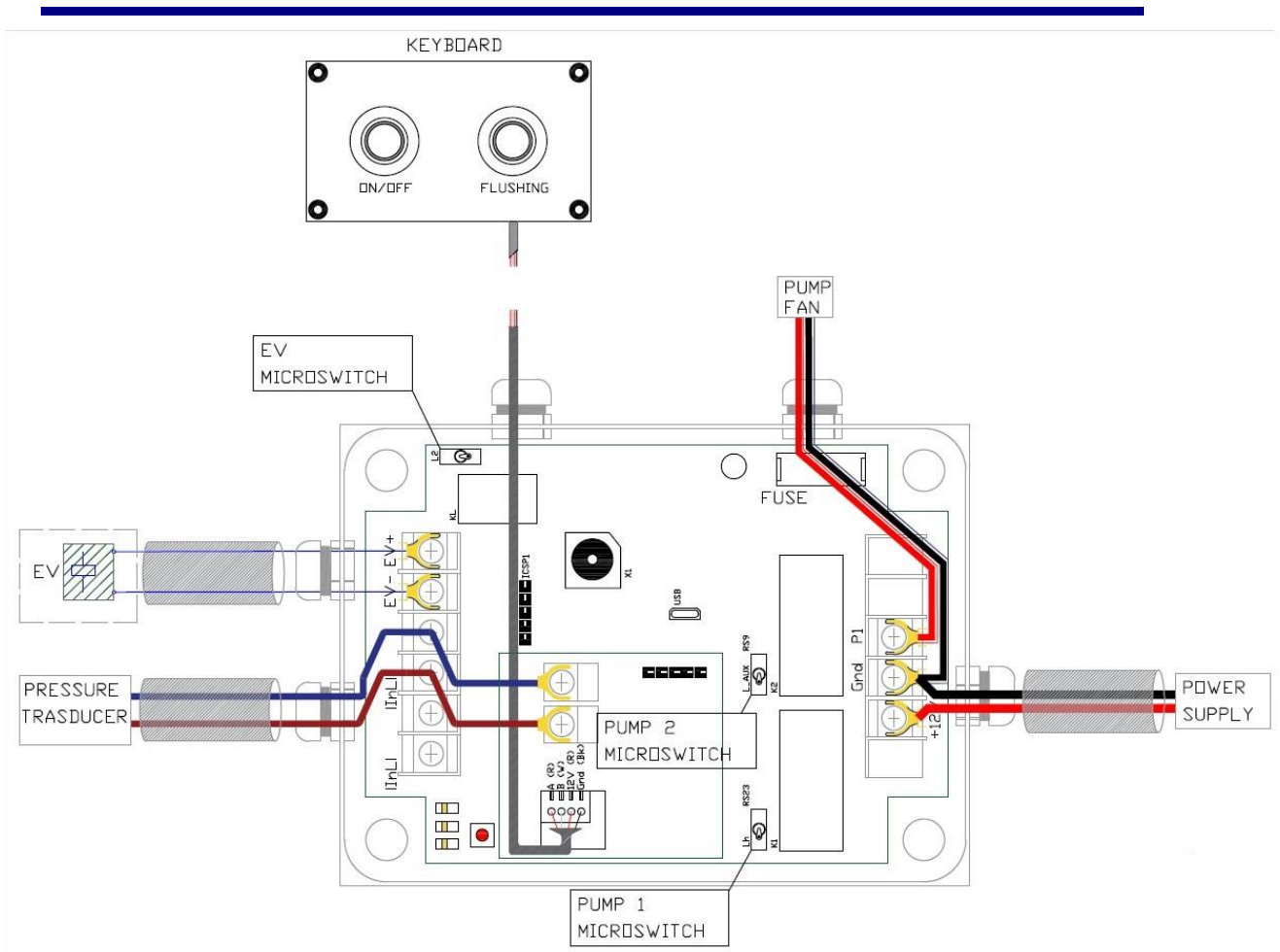

ELECTRIC MAIN BOX SCHEME ZEN 50 12/24V DC  
FIG. 4-10

## 5. FUNCTIONING AND USE

### 5.1 Command description



REMOTE CONTROL PANEL  
Fig. 5.1

#### KEYBOARD FEATURES

The panel keyboard has a total of 2 push buttons. The functions of the buttons are:

**ON/OFF** Used to start and stop the pumps of the system.

**FLUSHING** Used to activate the electrovalve and let the system rinse with fresh water.

#### 5.1.1 Alarms description

The system has three different types of alarm, recognizable by the flashing of the two LEDs on the pushing buttons. If the alarms occur, the controller immediately stops the unit:

- **Unit stalled:** the pressure is under the threshold value during the start – the system goes on alert after 5 seconds and the pushing buttons flash 2 times quickly;
- **Underpressure:** the pressure drops under the threshold value during the functioning – the system goes on alert and the pushing buttons flash 3 times quickly.
- **Overpressure:** the pressure raises over the threshold value during the functioning – the system goes immediately on alert and the pushing buttons flash 4 times quickly.
- **Low battery:** power supply is not sufficient - the system goes immediately on alert and the pushing buttons flash 5 times quickly.
- **Control failure:** the pressure transducer is faulty or not properly connected - the system goes immediately on alert and the pushing buttons flash 6 times quickly.

The alarm has to be stopped by pressing the button ON/OFF; then it is necessary to recognize and eliminate the problem before starting again the watermaker.

### 5.2 First start-up procedure

The first start-up procedure is necessary to start a new system, after a filter replacement or a chemical washing.



The start-up procedure is mainly aimed to purge the air separately from the unit and the 2 pumps.

## 5.2.1 Preliminary checks before proceeding with the start-up procedure

Perform the following checks before proceeding with the start-up procedure:

1. Verify all components and hoses are connected correctly.
2. Verify the 5 micron and active carbon cartridges are installed.
3. Check the seawater inlet valve and salt water drain valve (if existing) are open.
4. Check the reset valve is closed (lever orthogonal to the body valve) and the positioner completely unscrewed.
5. Check the fresh water pressurizing pump of the boat is on.
6. Check the grey valve on the active carbon filter is open.

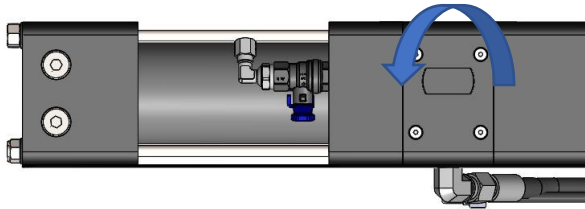
## 5.2.2 Start-up

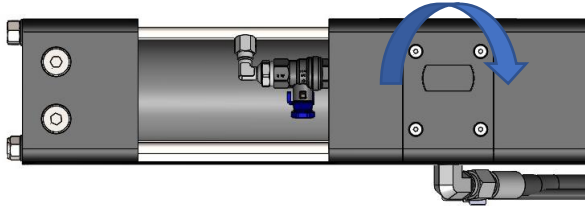
<p>1. Open the depressurization valve (unscrew the valve).</p>	
<p>2. Push Flushing for 5 seconds. The panel beeps twice, the button flashes quickly and the procedure starts. The unit can be stopped at any time by pushing the ON/OFF button.</p>	
<p>3. Start the unit again pushing ON/OFF. After about 4 minutes, the unit will stop (the fresh water system is now purged from air). Then start the unit again pushing ON/OFF.</p>	
<p>4. Close the depressurization valve. The system starts going under pressure and the fresh water production begins. Check the working pressure of the unit is correct (6,5 – 7,5 bar).</p>	



<p>5. After a while push FLUSHING in order to flush the unit before stopping it. Then the unit will stop after about 1 minute.</p>	
--	--

After completing the procedure, the system will be ready to start normally.

### 5.3 Normal operating procedure

Preliminary checks:

1. Check if the reset valve is closed (lever orthogonal to the body valve) and the positioner completely unscrewed.
2. Check if the depressurization valve is closed and that the grey valve on the active carbon filter is open.

#### 5.3.1 Normal operating procedure without final flushing

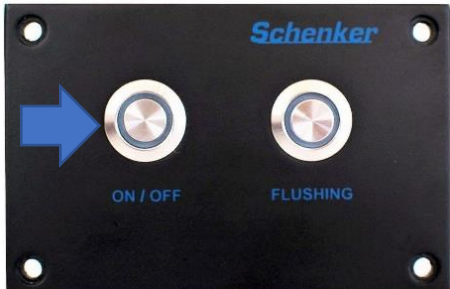
<ol style="list-style-type: none"> <li>1. Push ON/OFF to start the watermaker.</li> <li>2. Push ON/OFF to stop the watermaker.</li> </ol>	
---	--



**CAUTION:**

*The watermaker produces periodic “beats” during its functioning, due to the movement of the internal parts. A pressure peak is shown on the pressure gauge during these beats. Avoid to shut down the watermaker exactly on the beat, but wait a second after the beat to stop the unit properly.*

#### 5.3.2 Normal operating procedure with final flushing (recommended procedure)

<ol style="list-style-type: none"> <li>1. Push ON/OFF to start the watermaker.</li> <li>2. Push FLUSHING to flush and stop the watermaker. The watermaker will activate a flushing cycle then it will stop after 1 minute</li> </ol>	
--	--



### 5.3.3 Working cycle with timer

1. Keep ON/OFF pressed for a while, then you will hear 1-2-3-beeps. Once released ON/OFF, the watermaker will work for 1-2-3 hours, then it will flush and stop..
2. The unit can be stopped at any time by pushing the ON/OFF button (without final flushing) or the FLUSHING button (with final flushing).



#### CAUTION



The unit is based on 2 parallel pumps (pump 1 and pump 2). The unit works normally with both pumps, producing roughly 50 lit/h and drawing about 240 watt. The unit can also work with a single pump (either pump 1 or pump 2) producing 25 lit/h and drawing about 110 Watt. The sequence to activate a single pump is indicated below.

### 5.3.4 Working cycle with single pump

1. Keep ON/OFF and FLUSHING pressed for a while, then release FLUSHING. Next time watermaker will started, just Pump 1 will work.
2. Keep ON/OFF and FLUSHING pressed for a while, then release ON/OFF. Next time watermaker will be started, just Pump 2 will work.



#### CAUTION

After the cycle with a single pump the unit automatically will return to the normal 2 pumps mode.

### 5.3.5 Long flushing procedure

1. Push FLUSHING. A 3-minute flushing procedure with fresh water starts. Both ON/OFF and FLUSHING lights of the buttons are on.
2. The unit can be stopped at any time by pushing the ON/OFF button



## 5.4 Reset procedure

If the watermaker has sucked in air (or if other problems occur), the automatic hydraulic valve may stop in a central position.

In this case, when the unit has been started, it gets suddenly high pressure (close to 10 bar) without cycling. After few seconds the computer recognizes the problem and turns off the pump.

In this case the system has to be manually restarted.

Although this circumstance might be very unusual, it does not damage the system, but it is necessary to reset the valve with the following simple procedure:

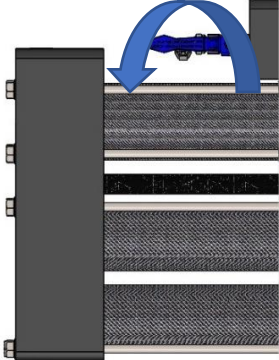
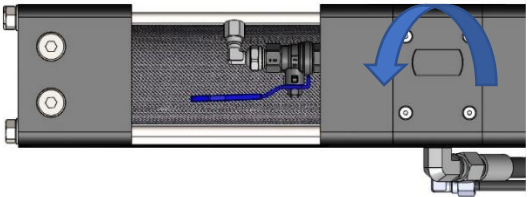
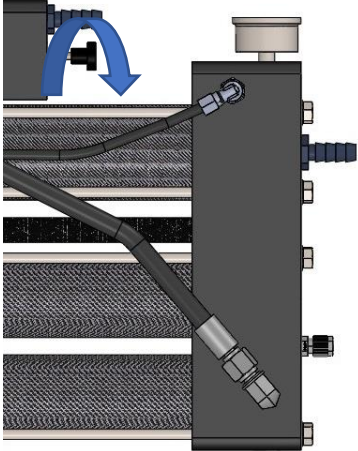
<p>1. Open the reset valve (lever in horizontal position).</p>	
<p>2. Open slightly the depressurization valve.</p>	
<p>3. Screw the positioner knob clockwise until it can be moved no further. Normally 18 complete turns at least are needed.</p>	

4. Unscrew the positioner knob counterclockwise back to its original position, until it can be turned no more.

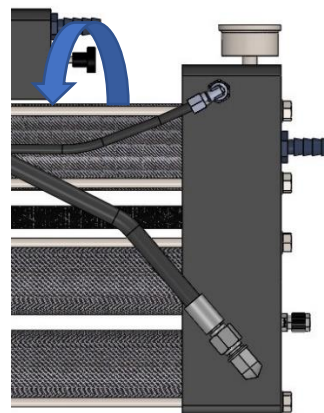

5. Close the reset valve (lever in vertical position).

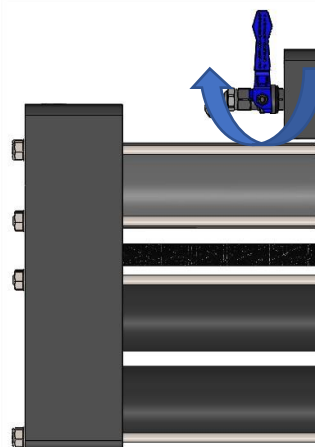

6. Restart the system.



7. After some seconds close the depressurization valve.

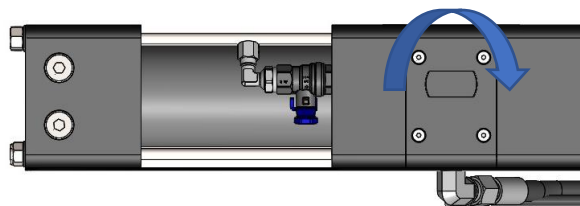

## 6. MAINTENANCE (ROUTINE AND SPECIAL)



### 6.1 Check filter cleanliness

It is very important to inspect filters condition periodically.

In the system there are the following:

1. Mesh filter (strainer).
2. Pump filter (5 micron cartridge filter – blue and white filter housing).
3. Active carbon filter.

In order to keep the filters properly clean, follow the tab illustrated hereby:

OPERATION	FREQUENCY	PROCEDURE
Check and clean the strainer	Every 5 days	<p><b>Visual inspection and washing</b></p> 
Replace the 5 micron cartridge filters	It depends on the working conditions and the turbidity of the sea water. In average conditions the replacement of the cartridge is recommended every 80-100 working hours. Once replaced the filters, it is necessary to purge the air from the system, opening for 2-3 minutes the depressurization valve.	<p><b>Unscrew the filter housing counter clockwise by using the specific key provided</b></p> 
Replace the active carbon fibre filter	Once per year	<p><b>Unscrew the filter housing counter clockwise by using the specific key provided</b></p> 

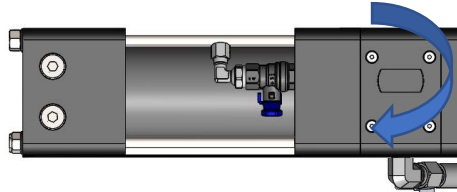
<p>Purge air from the system periodically by opening for 2-3 minutes the depressurization valve slightly.</p>	<p>Every 15-20 days</p>	
---	-------------------------	--

## 6.2 Check the watermaker working pressure

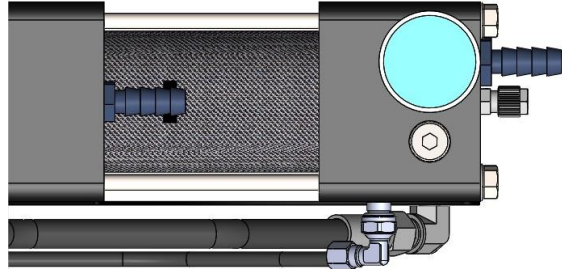
<p>The working pressure of the pump is indicated on the manometer of the main unit. The working pressure depends on many factors, such as water temperature, seawater salinity, batteries voltage, membranes conditions, typology of installation. The pressure, in normal working conditions, is in the range 6,5-7,5 bar. There is a periodic small pressure peak (during commutation) of 0,1-0,2 bar.</p>	
--	---

If the average pressure exceeds the above range, it is necessary to check the membranes cleanliness. If the pressure exceeds the abovementioned range, it's highly likely that the membranes are dirty or clogged, and it is necessary to perform a cleaning with the chemical SC1. If the cleaning with SC1 is not enough to reduce the pressure, it might be necessary an alkaline washing with the cleaning SC2.

## 6.3 Check for leaks

It is necessary to perform this verification at every watermaker start-up and frequently, as possible leaks due to accidental causes (hose bursting, hose clamp loosening, equipment failure, etc.) may occur causing possible damages.

## 6.4 Check for membranes replacement

The reverse osmosis membranes last for an average period of time of 6-7 years. When the membranes are old, the quality of water usually decreases whereas the working pressure increases. If chemical washings do not produce significant improvements, it is recommended to replace the membranes.

## 6.5 Shutdown procedure

It is necessary to perform the shutdown procedure before standstills longer than 2-3 months, for instance before the wintering.

The purpose of the shutdown is to flush the system. This might be useful in order to prevent the system from the creation of organic and inorganic sediments, as well as inhibit the growth of bacteria that could reduce the reverse osmosis membranes efficiency.

## 6.5.1 Necessary Equipment

The following equipment is necessary to perform the shutdown operation:

1. 1 tank of fill with at least 15 litres of fresh
2. 2 hoses to be connected to:
  - inlet of the pump
  - discharge of the watermaker
3. A bottle of powder **SCHENKER CLEANING 1 (SC1)**. The solution must be prepared following the instruction indicated on the bottle label, and **using unchlorinated water** ( for instance water produced by the system can be an option).
4. Tools for dismounting the system's pipes (screwdrivers, pliers, etc.)

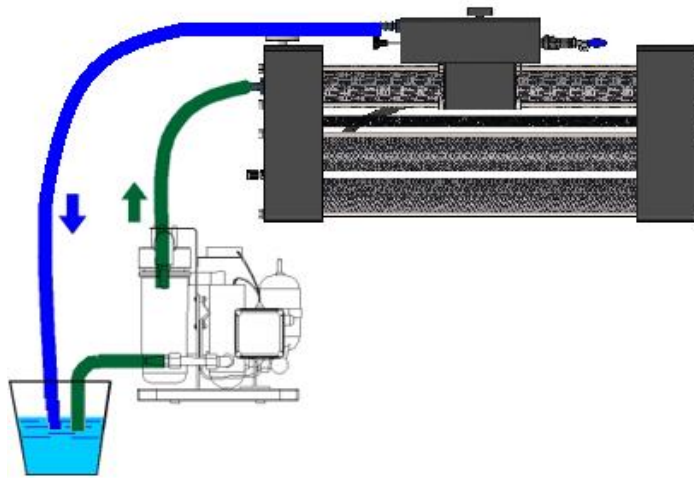

HYDRAULIC SCHEME FOR SHUTDOWN PROCEDURE  
FIG. 6-1



### NOTE

*The available products for the shutdown procedure are the followings:*

*1) SCHENKER CLEANING 1 (SC1 – Acid product) to remove the inorganic components and preserve the watermaker during winter break.*

*2) SCHENKER CLEANING 2 (SC2 – Alkaline product) to remove the organic components (mould and bacteria) when already deposited; in this case, the system and/or the water produce a “bad eggs” smell. Allow a period of 20 mins for both acid & alkaline cleaning.*

*It is important that the depressurizing valve is partially open when this procedure is carried out.*



### NOTE

*Normally only SC1 is required, but in case of strong bad smell (organic contamination) it is recommended to use SC2 as well.*

*The sequence in this case will be SC2 first, then a flushing of the unit with fresh water, and finally the SC1. Leave the product in the system to winterize the unit.*

*It is advisable to replace the filters after performed the cleaning procedure with new ones.*

*If the unit will not be used for a long period of time (for example before winter) the filters can also be removed*

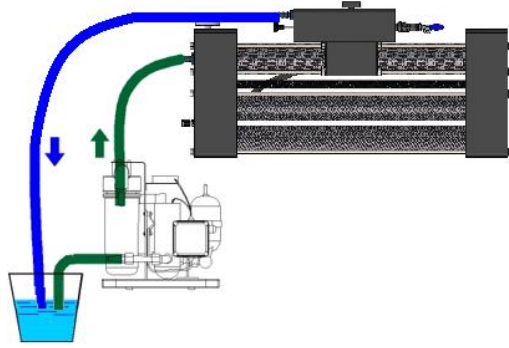
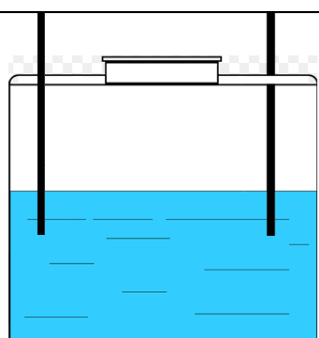
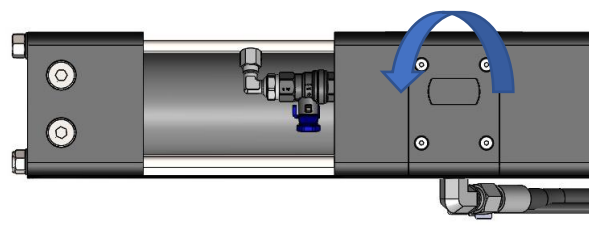

## 6.5.2 Shutdown operating procedure

<p>1. Prepare the solution carefully mixing the bottle of SC1(or SC2) in about 15 litres of unchlorinated water.</p>	
<p>2. Connect the 2 hoses to the pump and watermaker as indicated above, and dip them in the solution.</p>	
<p>3. Check they are well submerged in the solution and don't suck air.</p>	<p style="text-align: center;"><b>Pipes under the free water surface</b></p> 
<p>4. <b>Open the depressurization valve.</b></p>	

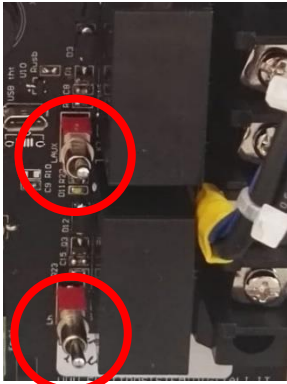
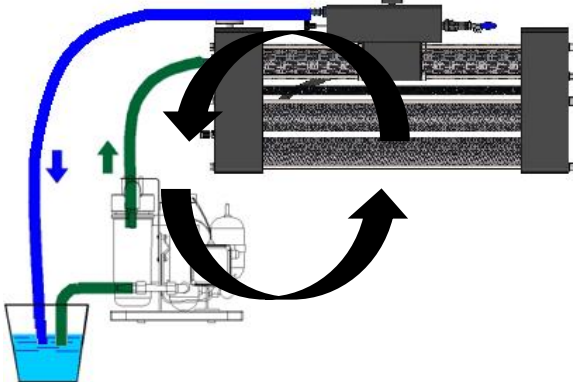
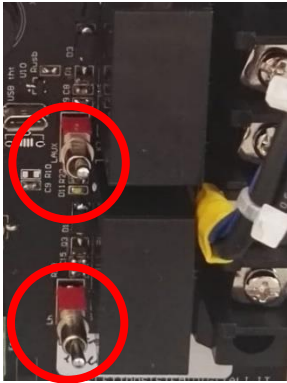
<p>5. Manually start the watermaker through the microswitches inside the pump box (switches down).</p>	
<p>6. Leave the unit running for approx. 20 minutes, checking that the hoses are properly positioned in the recipient, so that to avoid inhaling air.</p>	
<p>7. Manually stop the unit through the microswitches inside the pump box (switches up) and connect the original hose.</p>	



**CAUTION**

*It is necessary to perform the first start-up procedure when restarting the watermaker after a shutdown procedure, in order to purge the air and drain out chemicals in the systems.*



## 6.6 Antifreeze procedure (Winterizing procedure in cold climate - under 5°C)

It is recommended to first perform the normal shutdown procedure by using SC1 in order to prevent the system from the creation of organic and inorganic sediments, as well as inhibit the growth of bacteria that could reduce the reverse osmosis membranes efficiency.

After this operation, the system must be flushed and filled with an antifreeze.

The recommended antifreeze product is a solution of **propylene glycol and unchlorinated water**.

The ideal concentration of propylene glycol is

- 45% (for temperatures down to - 20°)
- 55% (for temperatures down to - 30°).



### ATTENTION

**Do not use ethylene glycol as this substance is toxic and non-degradable.**

The total volume of the solution must be about 15 litres.

The procedure is similar to that used for chemical washing with SC1 and SC2 products:

1. Prepare the solution carefully by mixing the propylene glycol with 15 litres of unchlorinated water and by following the concentration suggested above.
2. Disconnect the drain hose and the pumps suction hose.
3. Connect two hose pieces to the drain and to the pump suction.
4. Insert the end side of the hoses into the bucket, verifying that the hoses have been properly dipped in the solution and that they don't inhale air.
5. Open the depressurization valve.
6. Start the watermaker.
7. Leave the unit running for approx. 5 minutes.
8. Stop the unit and connect the original hoses. The antifreeze solution must stay in the system. Take care to not leave the system empty when reconnecting the hoses.

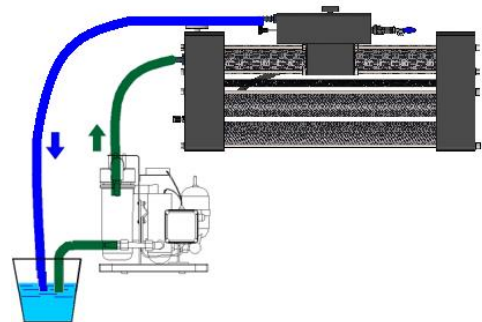

HYDRAULIC SCHEME FOR  
WINTERIZING PROCEDURE  
FIG. 6-2



### ATTENTION

**Before proceeding with any kind of service, it is strongly recommended to read carefully the instructions contained in this manual.**

## 6.7 Periodic maintenance

### 6.7.1 Membrane replacement

The reverse osmosis membranes last for an average period of time of 6-7 years. When the membranes are old, the quality of water usually decreases whereas the working pressure increases. If chemical washings do not produce significant improvements, it is recommended to replace the membranes.

## 6.8 Adjustments

### Accumulator

This is a cylindrical plastic reservoir of air that has the function of damping the pressure oscillations during the commutations of the watermaker. The accumulator is factory loaded at a pressure of about 4 bar. The charging pressure must be periodically checked.



## 7. TROUBLESHOOTING

### 7.1 Troubleshooting chart

Issue	Probable cause	Remedy
Pump does not start	Electronic failure	Start the pump and the electrovalve using microswitches
Pump starts but the system suddenly blocks in high pressure	Hydraulic block Dirty filters	Perform reset procedure Replace filters
During operation, the pump temporarily switches off, giving rise to a start and stop phenomenon	Dirty filters or membranes	Clean or replace
High pressure variations during commutation (> 0,2 Bar)	Low pressure in the accumulator	Inflate at a pressure of 4 Bar
Low production / normal or low pressure	Low battery Air within the system	Check battery charge Purge air opening for a while the pressure valve
Low production / high pressure (> 9 Bar)	Clogged filters Clogged membranes Cold seawater	Replace filters Perform washing with SC1 Normal condition

## 8. SUGGESTED SPARE PARTS

### 8.1 Short term cruising

For short term cruising, it is advisable to have onboard a cleaning kit (one SC1 and one SC2 cleaning product) as well as one 5 microns cartridge filter. Other additional spare parts are listed below with their codes:

<b>Spare part name</b>	<b>Code</b>
SC1 WASHING PRODUCT	SC1
SC2 WASHING PRODUCT	SC2
CLEANING KIT (SC1+SC2)	CK
5 MICRON CARTRIDGE 5	F5
ACTIVE CARBON FILTER CARTRIDGE	CA

### 8.2 Long term cruising

For long term cruising, it is advisable to have onboard a cruising kit (three x 5 microns cartridge filter, one active carbon filter, one cleaning kit). Other additional spare parts are listed below with their codes:

<b>Spare part name</b>	<b>Code</b>
SC1 WASHING PRODUCT	SC1
SC2 WASHING PRODUCT	SC2
CRUISING KIT	CRK136
SPARE PUMP SM-MOD 30/60 12V	SP36/12
SPARE PUMP SM-MOD 30/60 24V	SP36/24
MEMBRANE 2521	M2521
PORTABLE SALINITY TESTER	PST
PRESSURE TRANSDUCER	DPM
SPARE SEALS KIT ZEN50	SSZ5