

Operation and maintenance manual

WIKI



INDEX

1. LAYOUT OF MANUAL	3
1.1 STRUCTURE OF THE MANUAL	3
1.2 DESCRIPTION OF THE SYMBOLS	3
2. GENERAL WARNINGS AND INFORMATION TO THE RECIPIENT	4
2.1 IMPORTANT INFORMATION	4
2.2 SAFETY WARNINGS	4
2.3 LIMITED WARRANTY	5
2.4 IDENTIFICATION OF THE UNIT	6
2.5 REGULATIONS AND COMPLIANCE	6
2.5.1 <i>Guidelines and Regulations for Ensuring Machine Safety</i>	6
2.5.2 <i>Environmental Considerations: Guidelines for Removal and Disposal</i>	6
3. PRESENTATION OF THE PRODUCT	8
3.1 STORAGE	8
3.2 PACKAGE CONTENTS	8
3.2.1 <i>Included items</i>	8
3.3 TECHNICAL DATA	9
3.4 FEATURES OF THE PRODUCT	9
3.5 ADVANTAGES OF THE ENERGY RECOVERY SYSTEM	10
3.6 COMPOSITION OF THE SYSTEM	11
3.6.1 <i>Main components of the watermaker group</i>	11
3.6.2 <i>Accessories</i>	14
4. OPERATION	16
4.1 GENERAL CRITERIA	16
4.2 HOSES	16
4.3 ELECTRIC CONNECTIONS	17
5. STARTING	18
5.1 POSITIONING OF THE WATERMAKER AND HOSES	18
5.1.1 <i>Preliminary checks before proceeding with the start-up</i>	18
5.1.2 <i>Starting</i>	18
5.1.3 <i>Turning off the machine</i>	19
5.1 RESET PROCEDURE	20
6. MAINTENANCE (ROUTINE AND SPECIAL)	22
6.1 CHECK FILTER CLEANING	22
6.2 FLUSHING PROCEDURE	23
6.3 CHECK THE WATERMAKER WORKING PRESSURE	23
6.4 CHECK FOR LEAKS	23
6.5 CHECK FOR MEMBRANES REPLACEMENT	23
6.6 SHUTDOWN PROCEDURE	23
6.6.1 <i>Necessary Equipment</i>	24
6.6.2 <i>Shutdown operating procedure</i>	25
6.7 ANTIFREEZE PROCEDURE (WINTERIZING PROCEDURE IN COLD CLIMATE - UNDER 5°C)	27
6.8 PERIODIC MAINTENANCE	28
6.8.1 <i>Membrane replacement</i>	28
6.9 ADJUSTMENTS	28
7. TROUBLESHOOTING	29

7.1	TROUBLESHOOTING CHART	29
8.	SUGGESTED SPARE PARTS	30
8.1	SHORT TERM CRUISING	30
8.2	LONG TERM CRUISING	30

1. LAYOUT OF MANUAL

1.1 Structure of the manual

The manual is divided into chapters, which gather all the information necessary to use the system without risks.

In each chapter there is a subdivision in paragraphs to focus on essential points; each paragraph can be found with a subtitle and a description.

In each chapter, for example chapter 1, we have:

1	Chapter title
1.1	Paragraph title
1.1.1	Subtitle

1.2 Description of the symbols

The following symbols shall be used in the manual to highlight important indications and warnings:



ATTENTION:

This symbol indicates accident prevention regulations for the operator and / or for any exposed persons.



CAUTION:

This symbol indicates that there is the possibility of damaging the system and / or its components.



NOTE:

This symbol indicates useful information.

2. GENERAL WARNINGS AND INFORMATION TO THE RECIPIENT

2.1 Important information

In order to safeguard the operator's safety and avoid possible damages to the machine, before carrying out any operation on the machine, it is essential to read carefully all the instructions.

This manual must be left complete and legible in its entirety, every operator involved in the use of the machine, or responsible for maintenance or adjustment operations, must know its location and must have the possibility to consult it any time.

All rights of reproduction of this manual are reserved to SCHENKER ITALIA. This manual cannot be transferred to third parties without the written authorization of SCHENKER ITALIA.

The text cannot be used in other documents without the written permission of SCHENKER ITALIA.

The descriptions and illustrations provided in this publication are not binding.

SCHENKER ITALIA reserves the right to make any modifications considered appropriate.

© SCHENKER ITALIA

THIS MANUAL IS PROPERTY OF SCHENKER ITALIA, ANY REPRODUCTION, EVEN PARTIAL, IS PROHIBITED.

This manual was drafted according to the requirements of the 2006/42 / EC Machinery Directive.

2.2 Safety warnings

- Verify that the electric and hydraulic connections follow the indicated specifications.
- Avoid using the watermaker if the sea water is polluted.
- Children and inexperienced people shall not touch or use the system.
- Ensure there are no leaks. Avoid placing the system in a location where a leak could result in harm or pose a risk to the vessel's safety.

2.3 Limited warranty

The equipment and the relevant accessories are subject to a 12-month limited warranty from delivery date. The limited warranty does not include consumable items (filters, carbon filters, membranes, etc.). The "ERS" pressure amplification device is subject to a 36-month limited warranty, as long as the watermaker is given a proper maintenance by a specialized Schenker technician. The limited warranty covers faults due to defected materials and parts. It is limited to the replacement or repair of faulty parts. The charge for the disconnecting and reinstalling on the vessel, as well as transportation from or to our Service Point (or our factory) shall be at the customers own expenses.

Delivery of parts subject to this limited warranty shall be at customer's own risk.

In case of repairs under this limited warranty performed by our technicians on the customer's vessel, the faulty parts replacement cost shall be at Schenker's expense, while manpower and travel expenses will be charged to the customer. The limited warranty does not include faults caused by negligence in operating, maintenance and installation of the device (if not carried out by an authorised Schenker Service point).

Dismantling by non-authorized personnel will invalidate the limited warranty. Schenker Italia will not be responsible for any direct or indirect damage caused by the malfunctioning equipment, limiting its liability to the repair and replacement of faulty parts.

Except for the limited warranty set forth above, Schenker italia makes no warranty whatsoever with respect to the products, including any (a) warranty of merchantability; (b) warranty of fitness for a particular purpose; (c) warranty of title; or (d) warranty against infringement of intellectual property rights of a third party; whether express or implied by law, course of dealing, course of performance, usage of trade or otherwise

Lack of general maintenance, (See 6. MAINTENANCE (ROUTINE AND SPECIAL, the use of non-genuine Schenker spares, may reduce the life expectancy of the pump(s), ERS & membrane. It should also be noted that using a watermaker in silty or contaminated water can introduce impurities into the system causing damage in the form of scratches to the internal components. This will affect the efficiency of the watermaker and is not covered by warranty.



ATTENTION

SCHENKER ITALIA declines any responsibility for improper use of the machine, for damages caused as a result of operations not covered by this manual or unreasonable use.

2.4 Identification of the unit

The Wiki Watermaker can be identified by a serial number printed on a label on the top valve of the unit.



Serial number
Fig. 2-1

2.5 Regulations and compliance

2.5.1 Guidelines and Regulations for Ensuring Machine Safety

- Machinery Directive 2006/42 / EC, in force since December 29, 2009;
- Low Voltage Directive 73/23 / EEC and subsequent amendments and additions: 93/68 / CEE implemented by the Law of 18 October 1997 n. 791.
- Electromagnetic Compatibility Directive 89/336 / EEC and subsequent amendments and additions: 93/31 / CEE implemented with D.L. December 4, 1992 n. 476.
- Standards UNI EN 292/1 and 292/2 (safety of machinery);
- Supply of Machinery (Safety) Regulations 2008 - S.I. 2008:1597
- Electrical Equipment (Safety) Regulations 2016 - S.I. 2016:1101
- Electromagnetic Compatibility Regulations 2016 - S.I. 2016:1091

2.5.2 Environmental Considerations: Guidelines for Removal and Disposal



ATTENTION

Removal and disposal of materials, as result of the decommissioning of the machine, must be performed in accordance with the regulations in force, for the safeguard and protection of the environment.

According to removal and disposal, it should be highlighted that the construction materials of the machine are not dangerous for the environment and consist essentially of:

- Stainless Steel;
- Plastic;

- Carbon fibre;
- Motors, cables and consumable electrical materials;
- Rubber and polyurethane seals.

The various materials must be discarded according to the regulations of the country where the machine has been dismissed.

The machine does not contain dangerous components or substances that require special removal procedures.



ATTENTION

Different legislations are in force in the different countries, therefore the prescriptions imposed by the laws and by the agencies designated by the Countries must be observed.

3. PRESENTATION OF THE PRODUCT

3.1 Storage



ATTENTION

To avoid damage to the system, be sure to keep the unit in a dry place with a temperature between 5°C and 45°C. Very cold temperatures could lead to a freezing of the fluid inside the system and, as a clear consequence, a permanent mechanical damage.

3.2 Package contents

3.2.1 Included items



SYSTEM
FIG. 3-1

WIKI

Watermaker group:

Energy Recovery System
5-micron filter
Accumulator
Pump
Electric box

Hoses and accessories:

Inlet hose with net filter and non-return valve
Discharge hose
6x8 hose for production
Filter key
Maintenance hoses
Portable tank

3.3 Technical data

WATERMAKER

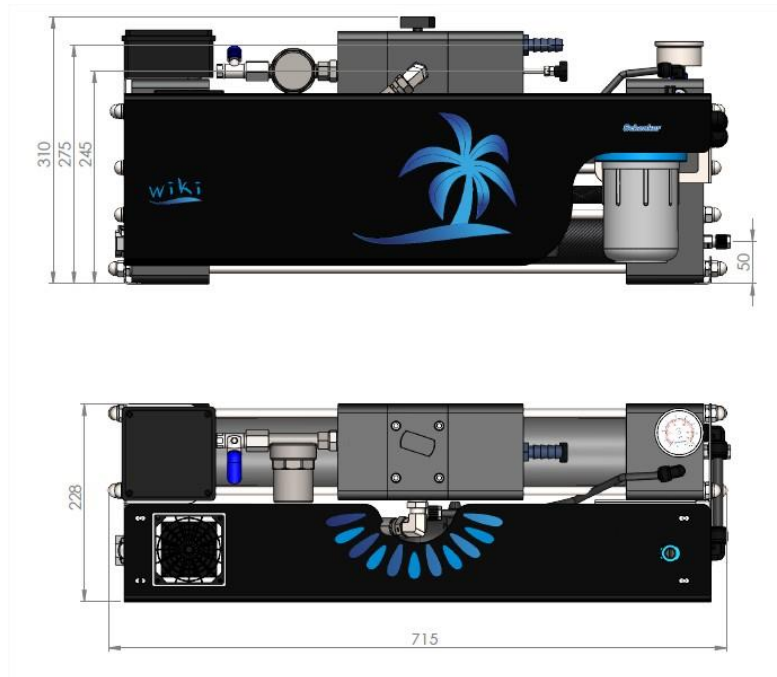

WATERMAKER DIMENSIONS
FIG. 3-2

Weight:	26 Kg
Feed pump type:	Diaphragm pump
Filters:	No. 1 Cartridge filter 5 microns 2.32" x 5"
Power supply:	12/24 VDC +/- 15%
Average electric consumption:	110 Watt/h average
Nominal fresh water production:	30 Lit/h +/- 20% @ seawater 25 °C salinity 35.000 ppm
CEE conformity:	In compliance with directives 89/392 CEE sect.1 (general safety machines requirements), 89/336 CEE (electromagnetic compatibility), 73/23 CEE (electric safety requirements)

3.4 Features of the product

The fresh water produced by a Schenker watermaker, obtained by clean seawater, has a high purity. Despite this, the potability may not be guaranteed: bacterium caused by non-observance of shutdown and cleaning procedures may be present in the watermaker. Therefore, it is essential that the correct shut down and storage procedures are followed to ensure continued purity of the fresh water. Furthermore, to improve the water safety it is strictly recommended to install a backup treatment on board, such as a UV sterilizer or a microfiltration system.

3.5 Advantages of the Energy recovery system

Introduction

Thank you for choosing a Schenker Watermaker.

The knowledge of operating and maintenance procedures allows to use the system in the best way, and to guarantee a perfect functioning throughout the years. We invite you to read carefully this manual and to keep it for a quick reference.

Functioning principles

The Schenker watermakers, as an alternative to the high-pressure pumps of traditional systems, use the ENERGY RECOVERY SYSTEM patented device, which amplifies the pressure of common low-pressure pumps, and recover all the hydraulic energy back from the membranes, allowing a high energy efficiency.

The lack of high-pressure pumps makes the system silent and vibration-free and enormously simplifies its use since no adjustment is necessary for its operating.

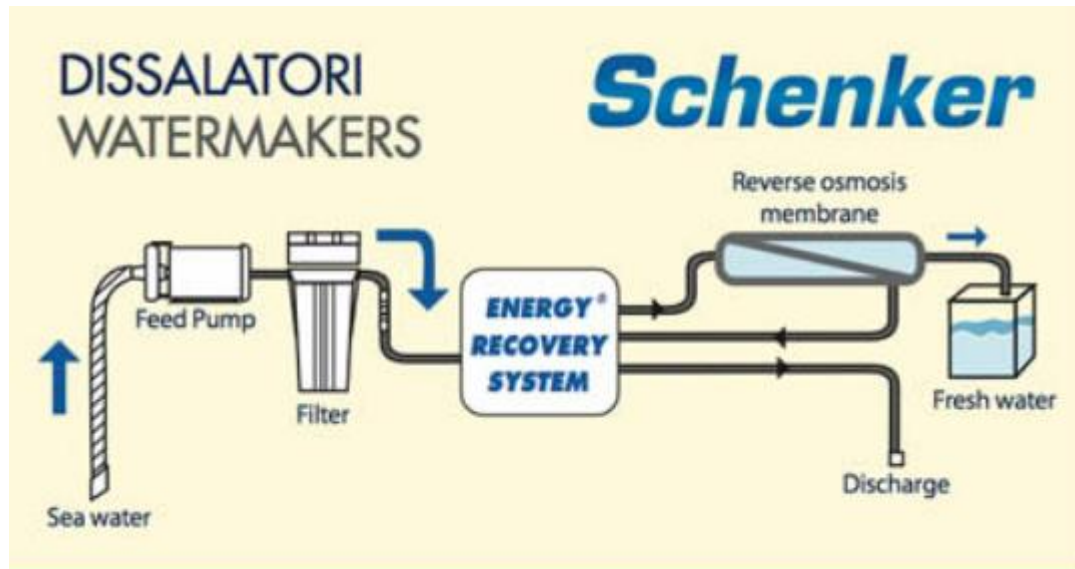

FUNCTIONING SCHEME
FIG. 3-3

3.6 Composition of the system

The system is composed of the following parts:

- Watermaker group
- Accessories

3.6.1 Main components of the watermaker group



WATERMAKER FRONT SIDE
FIG. 3-4

- ❶ Reset valve
- ❷ Antishock

- ❸ Depressurization valve
- ❹ Manometer

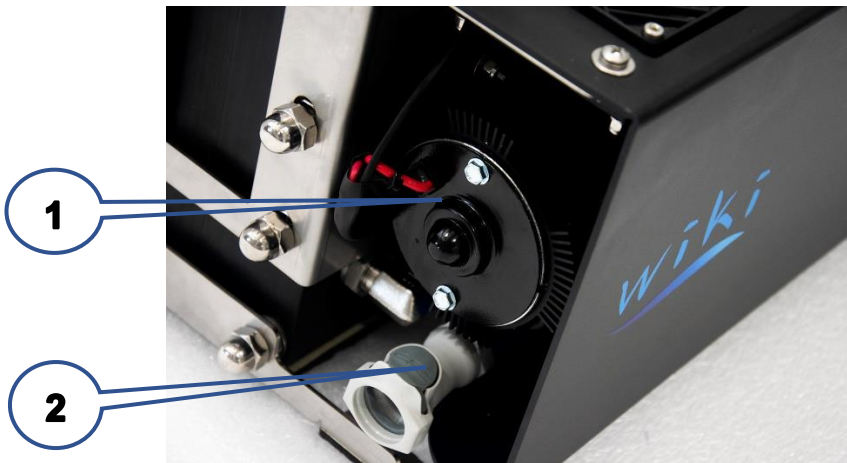

WATERMAKER LEFT SIDE
FIG. 3-5

- ❶ Low pressure pump

- ❷ Watermaker inlet

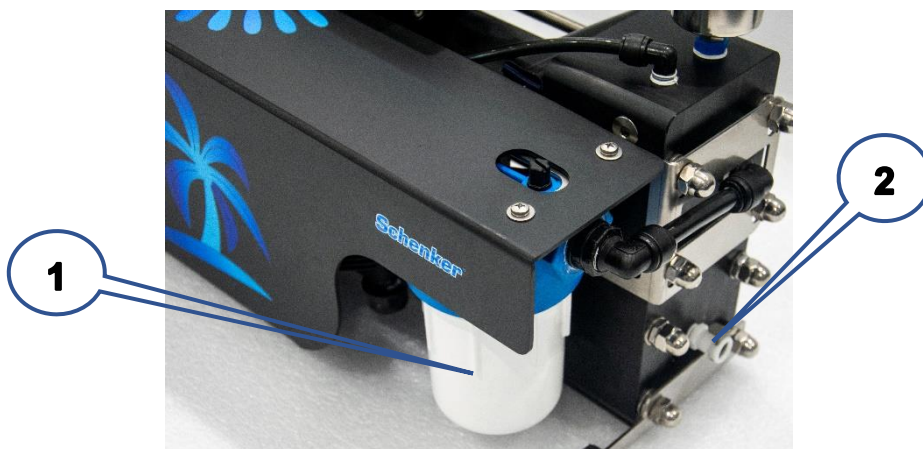

WATERMAKER RIGHT SIDE
FIG. 3-6

❶ 5 micron filter

❷ Freshwater outlet

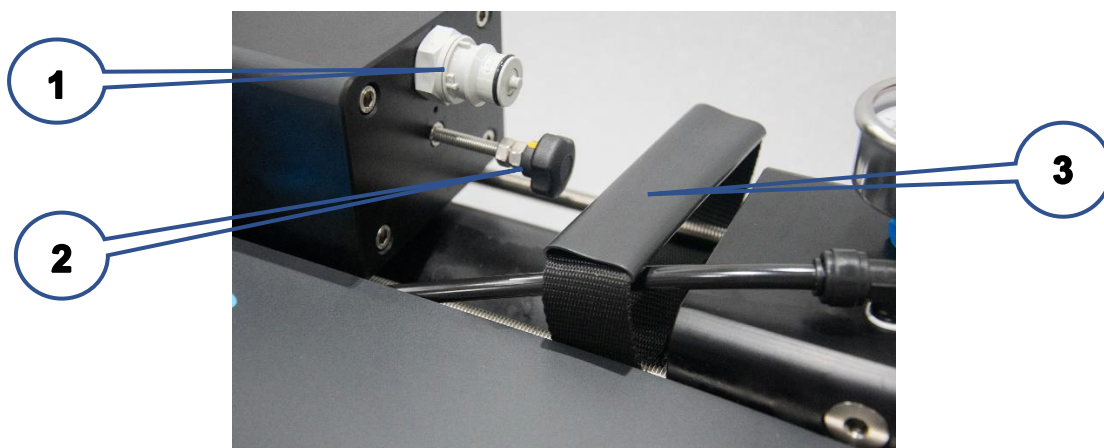

WATERMAKER TOP SIDE
FIG. 3-7

❶ Watermaker outlet/discharge
❷ Reset positioner

❸ Watermaker handle

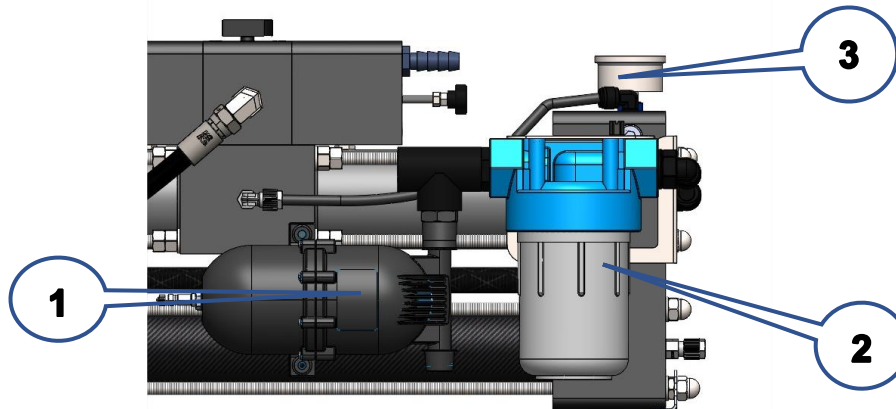

WATERMAKER W/O COVER
FIG. 3-8

- ① Accumulator
- ② 5 micron filter

- ③ Manometer

The watermaker group is composed of the following parts:

- Reverse osmosis membranes
- Energy Recovery System
- Manometer
- Accumulator
- Depressurization valve
- Positioner
- Reset valve
- Antishock

Reverse osmosis membrane. It is installed inside the carbon fibre high-pressure housing. Membrane is n.1 x SW2521 type. Its purpose is to separate the intake high-pressure seawater in two flows: one for the salt-water drain and one for the fresh water production.

Energy Recovery System. The heart of the system. Its main function is to amplify the pressure supplied by the pumps and to recover the hydraulic energy back from the membranes. The ERS device makes periodic cycling by a hydraulically controlled automatic valve. The cycles are noticeable through a "beat" emitted by the watermaker unit. The unit is based on cylinders and a central body containing the hydraulic valve necessary for the system to function.

Manometer. Located on the right side of the watermaker, it measures the working pressure of the watermaker.

Accumulator. This is an air accumulator installed after the cartridge filter group. Its function is to reduce and stabilize the pressure peaks during the functioning of the watermaker. The device has to be pre-charged with air through the Schrader valve. The pressure is about 4 Bar. The accumulator is already pre-charged to the correct pressure.

Depressurization valve. It is used for the air bleeding of the unit. It is located on the top of the watermaker. Its function is to depressurize the system and to allow the bleeding of air. The valve must be closed during normal working conditions (completely screwed in) and it is opened during the air bleeding operations (slightly unscrewed).

Positioner. It is a stainless steel threaded shaft, with a black knob, located on the right hand side of the watermaker. Its function is to reset the unit in case of hydraulic block.

Reset valve. It is installed on top of the ERS. It is recognizable by the little blue lever. The valve must be closed during normal functioning (lever perpendicular to the valve). This valve has the function of allowing the resetting of the ERS in case of a system block. It must be opened before screwing in the valve positioner.

Antishock. It is a small accumulator. Its function is to stabilize the cycling of the unit.

3.6.2 Accessories

The main accessories of the system are the following:

- Discharge hose – 3 mt
- Inlet hose with non-return valve and net filter – 4mt
- Fresh water hose – 10 mt
- Maintenance hoses – 4mt
- Portable tank

Non-return valve (or check valve). It stops water flowing out of the inlet hose.

Mesh filter. The machine is equipped with a strainer to protect the pump from macro sediments.

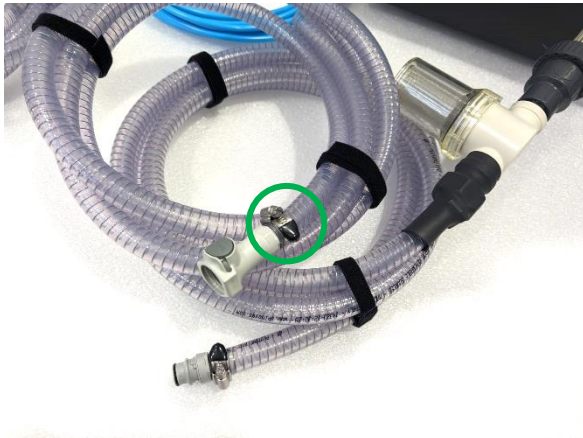

Inlet hose with non-return valve and net filter
Black flag



Maintenance hose
Red flag

PROVIDED HOSES
FIG. 3-9

Portable tank. A 15-liter foldable tank that can be used to store the produced fresh water for the flushing or for maintenance.

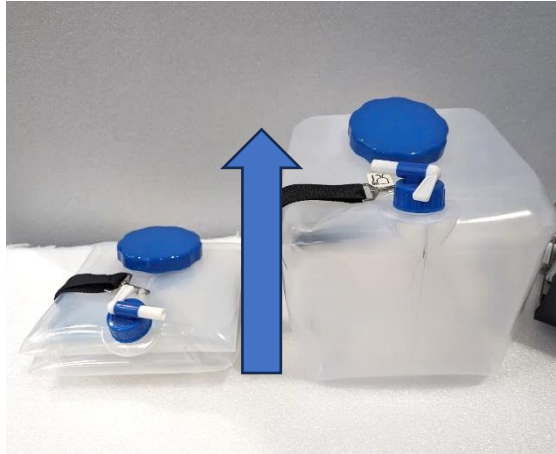

PORTABLE TANK
FIG. 3-10

4. OPERATION

4.1 General criteria

Place the machine on the stern of the boat, possibly quite close to the waterline of the boat. The maximum recommended height from the sea surface for the placement of the watermaker group is 1.5 meters. The best locations are:

- The stern platform
- The boat cockpit



ATTENTION

The external surface of motor of the pump can reach high temperatures; therefore, it is recommended to avoid possible contacts with inflammable liquids and materials.



ATTENTION

The watermaker is equipped with anchoring systems to prevent damage during use

4.2 Hoses

Be sure to firmly secure the inlet and the discharge hoses; they should be submerged in the sea at an appropriate distance from each other.

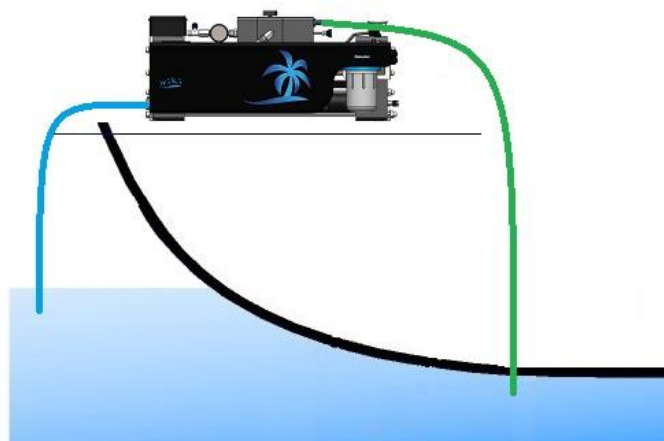

WATERMAKER PLACEMENT
FIG. 4-1

4.3 Electric connections

The 12/24 V power supply, from the service batteries, must be connected to the provided plug. A 16 Ampere automatic circuit breaker for 12V systems must be installed on the power supply, while a 10 Ampere for 24V systems.

The connection must be suitable to take the typical electric load (110-150Watt continuous)

The power supply cable section is related to the length of the cable.

The maximum length of the cables for 12V systems is 4 meters (4 meters for the positive + 4 meters for the negative)

Voltage Volt	Breaker Ampere	Cable length 4m	
		mm2	AWG
12	16	10	7
24	10	4	11

5. STARTING

5.1 Positioning of the watermaker and hoses

- Place the machine on the stern of the boat, possibly quite close to the waterline of the boat.
- Connect the intake and exhaust hoses as shown in the figure:

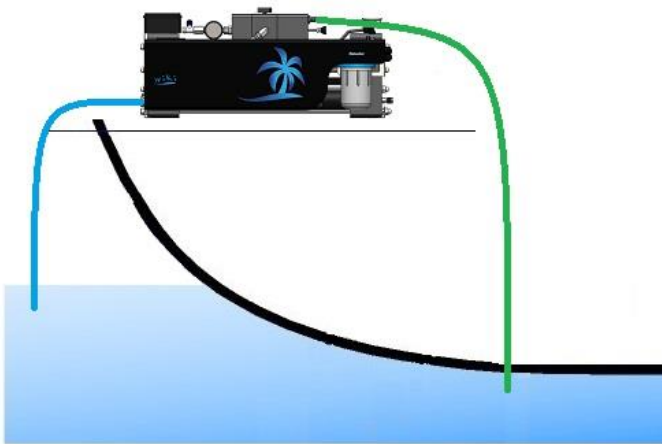

- Connect the fresh water production hose (blue tube) to the watermaker and insert the end of the tube into the fresh water inlet hose of the boat.

5.1.1 Preliminary checks before proceeding with the start-up

Perform the following checks before proceeding with the start-up procedure:

1. Check that the machine is positioned stably and safely. Possibly secure it to some fixed point of the boat with a rope.
2. Check the inlet and exhaust hoses, as well as the fresh water hose, are placed correctly
3. Check the reset valve is closed (lever orthogonal to the body valve) and the positioner completely unscrewed.

5.1.2 Starting

- 1 Open the depressurization valve (unscrew the valve).

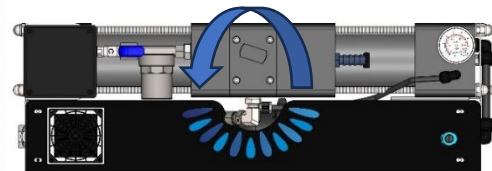

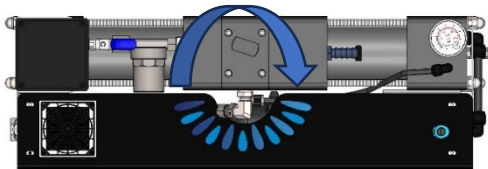
2 Fill the inlet hose of the watermaker with water in order to allow the pump to prime.	
3 Turn on the watermaker	
4 After 1 minute, close the depressurization valve. The system starts going under pressure and the fresh water production begins. Check the working pressure of the unit is correct (6,5 – 7,5 bar).	

5.1.3 Turning off the machine

At the end of production (which can be estimated at 30 litres/h), turn off the watermaker using the switch. It is recommended to turn off the watermaker immediately after the typical “knock” of the machine (just after the beep).



Disconnect the pipes, empty them of water, disconnect the electrical cable and place the watermaker and pipes in the appropriate bags.

5.1 Reset procedure

If the watermaker has sucked in air (or if other problems occur), the automatic hydraulic valve may stop in a central position.

In this case, when the unit has been started, it gets suddenly high pressure (close to 10 bar) without cycling. In this case the system has to be manually resetted.

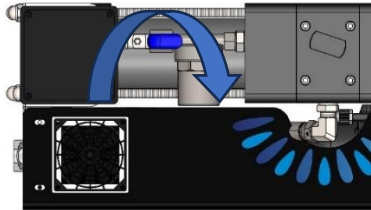
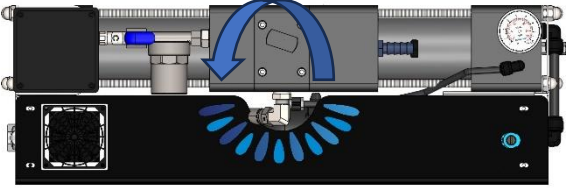
Although this circumstance might be very unusual, it does not damage the system, but it is necessary to reset the valve with the following simple procedure:

<p>1. Open the reset valve (lever in horizontal position).</p>	
<p>2. Open slightly the depressurization valve.</p>	
<p>3. Screw the positioner knob until it can be moved no further. Normally 18 complete turns at least are needed.</p>	

4. Unscrew the positioner knob back to its original position, until it can be turned no more.

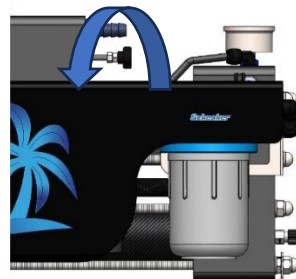

5. Close the reset valve (lever in vertical position).

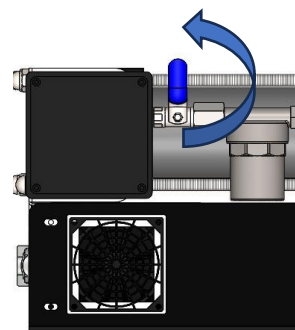

6. Close the depressurization valve (screw the valve).

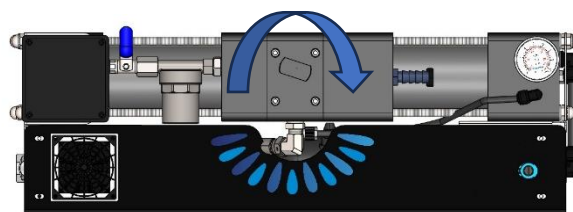

7. Restart the system.



6. MAINTENANCE (ROUTINE AND SPECIAL)



6.1 Check filter cleaning

It is very important to inspect filters condition periodically.

In the system there are the following:

1. Mesh filter (strainer).
2. Pump filter (5 micron cartridge filter – blue and white filter housing).

In order to keep the filters properly clean, follow the tab illustrated hereby:

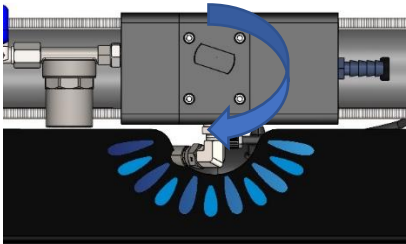
OPERATION	FREQUENCY	PROCEDURE
Check and clean the strainer	Every 5 days	<p>Visual inspection and washing</p> 
Replace the 5 micron cartridge filters	It depends on the working conditions and the turbidity of the sea water. In average conditions the replacement of the cartridge is recommended every 50/60 working hours. Once replaced the filters, it is necessary to purge the air from the system, opening for 2-3 minutes the depressurization valve.	<p>Unscrew the filter housing counter clockwise by using the specific key provided</p> 
Purge air from the system periodically by opening slightly the depressurization valve for 2-3 minutes	Every 15-20 days	

6.2 Flushing procedure

It is necessary to carry out a washing procedure preferably after each use of the machine in order to remove the salt contained in the machine and to extend the life of the reverse osmosis membrane. For this procedure, 5 liters of non-chlorinated water must be used (the water produced by the watermaker is perfect for the purpose). Maintenance hoses are supplied with the system to make the process easier.

The washing procedure is as follows.

- Collect 5-6 liters of non-chlorinated fresh water in the portable tank (the one produced by the watermaker is fine).
- Connect the maintenance suction hose to the watermaker and immerse the hose in the tank.
- Connect the drain hose to the watermaker and leave it overboard (or in a vessel drain).
- Open the depressurization valve (approximately ¼ turn).
- Activate the watermaker until the fresh water contained in the tank is completely empty.

6.3 Check the watermaker working pressure

The working pressure of the pump is indicated on the manometer of the main unit.

The working pressure depends on many factors, such as water temperature, seawater salinity, batteries voltage, membranes conditions

The pressure, in normal working conditions, is in the range 6,5-7,5 bar. There is a periodic small pressure peak (during commutation) of 0,1-0,2 bar.



If the average pressure exceeds the above range, it is necessary to check the membranes cleanliness. If the pressure exceeds the abovementioned range, it's highly likely that the membrane is dirty or clogged, and it is necessary to perform a cleaning with the chemical SC1. If the cleaning with SC1 is not enough to reduce the pressure, it might be necessary an alkaline washing with the cleaning SC2.

6.4 Check for leaks

It is necessary to perform this verification at every watermaker start-up and frequently, as possible leaks due to accidental causes (hose bursting, hose clamp loosening, equipment failure, etc.) may occur causing possible damages.

6.5 Check for membranes replacement

The reverse osmosis membranes last for an average period of time of 6-7 years. When the membranes are old, the quality of water usually decreases whereas the working pressure increases. If chemical washings do not produce significant improvements, it is recommended to replace the membranes.

6.6 Shutdown procedure

It is necessary to perform the shutdown procedure before standstills longer than 2-3 months, for instance before the wintering.

The purpose of the shutdown is to flush the system. This might be useful in order to prevent the system from the creation of organic and inorganic sediments, as well as inhibit the growth of bacteria that could reduce the reverse osmosis membranes efficiency.

6.6.1 Necessary Equipment

The following equipment is necessary to perform the shutdown operation:

1. The provided plastic tank filled with at least 15 litres of fresh water;
2. 2 hoses (provided) to be connected to:
 - inlet of the pump (red flag hose)
 - discharge of the watermaker
3. A bottle of powder **SCHENKER CLEANING 1 (SC1)**. The solution must be prepared following the instruction indicated on the bottle label, and **using unchlorinated water** (for instance water produced by the system can be an option).

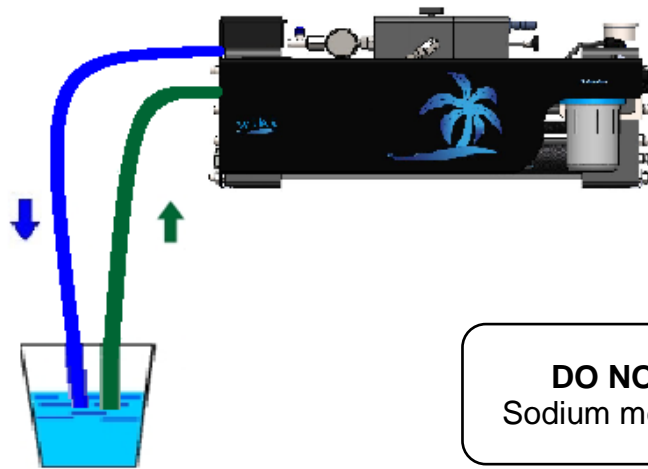

HYDRAULIC SCHEME FOR SHUTDOWN PROCEDURE
FIG. 6-1



NOTE

The available products for the shutdown procedure are the followings:

1) SCHENKER CLEANING 1 (SC1 – Acid product) to remove the inorganic components and preserve the watermaker during winter break.

2) SCHENKER CLEANING 2 (SC2 – Alkaline product) to remove the organic components (mould and bacteria) when already deposited; in this case, the system and/or the water produce a "bad eggs" smell. Allow a period of 20 mins for both acid & alkaline cleaning.

It is important that the depressurizing valve is partially open when this procedure is carried out.



NOTE

Normally only SC1 is required, but in case of strong bad smell (organic contamination) it is recommended to use SC2 as well.



The sequence in this case will be SC2 first, then a flushing of the unit with fresh water, and finally the SC1. Leave the product in the system to winterize the unit.

It is advisable to replace the filters after performed the cleaning procedure with new ones.

If the unit will not be used for a long period of time (for example before winter) the filters can also be removed.

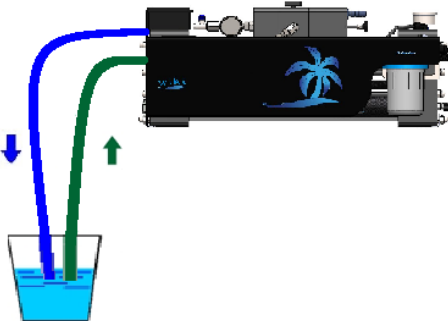
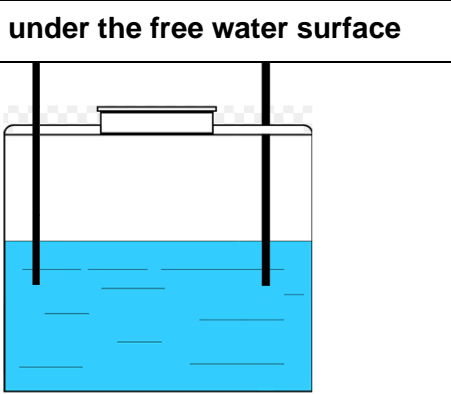
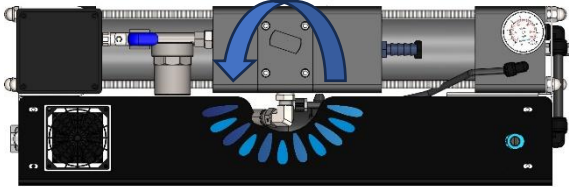
6.6.2 Shutdown operating procedure

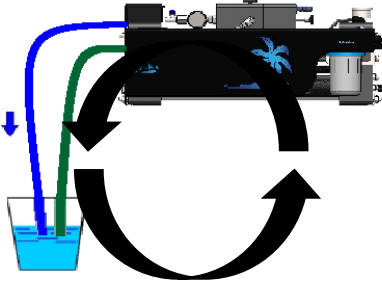
<p>1. Prepare the solution carefully mixing the bottle of SC1(or SC2) in about 15 litres of unchlorinated water.</p>	
<p>2. Connect the 2 maintenance hoses to watermaker as indicated above, and dip them in the solution.</p>	
<p>3. Check they are well submerged in the solution and don't suck air.</p>	<p style="text-align: center;">Pipes under the free water surface</p> 
<p>4. Open the depressurization valve.</p>	

<p>5. Start the watermaker</p>	
<p>6. Leave the unit running for approx. 20 minutes, checking that the hoses are properly positioned in the recipient, in order to avoid inhaling air.</p>	
<p>7. Stop the unit and connect the original hoses.</p>	



CAUTION

It is necessary to perform the first start-up procedure when restarting the plant after a shutdown procedure, in order to purge the air and drain out chemicals in the systems.

6.7 Antifreeze procedure (Winterizing procedure in cold climate - under 5°C)

It is recommended to first perform the normal shutdown procedure by using SC1 in order to prevent the system from the creation of organic and inorganic sediments, as well as inhibit the growth of bacteria that could reduce the reverse osmosis membranes efficiency.

After this operation, the system must be flushed and filled with an antifreeze.

The recommended antifreeze product is a solution of **propylene glycol and unchlorinated water**.

The ideal concentration of propylene glycol is

- 45% (for temperatures down to - 20°)
- 55% (for temperatures down to - 30°).



ATTENTION

Do not use ethylene glycol as this substance is toxic and not-degradable.

The total volume of the solution must be about 15 litres.

The procedure is similar to the one used for chemical washing with SC1 and SC2 products:

1. Prepare the solution carefully by mixing the propylene glycol with 15 litres of unchlorinated water and by following the concentration suggested above.
2. Disconnect the drain hose and the pumps suction hose.
3. Connect two hose pieces to the drain and to the pump suction.
4. Insert the end side of the hoses into the bucket, verifying that the hoses have been properly dipped in the solution and that they do not inhale air.
5. Open the depressurization valve.
6. Start the watermaker.
7. Leave the unit running for approx. 5 minutes.
8. Stop the unit and connect the original hoses. The antifreeze solution must stay in the system. Take care to not leave the system empty when reconnecting the hoses.

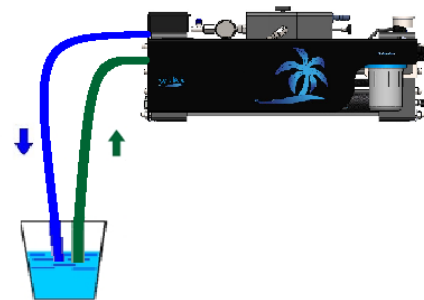

HYDRAULIC SCHEME FOR
WINTERIZING PROCEDURE
FIG. 6-2



ATTENTION

Before proceeding with any kind of service, it is strongly recommended to read carefully the instructions contained in this manual.

6.8 Periodic maintenance

6.8.1 Membrane replacement

The reverse osmosis membranes last for an average period of time of 6-7 years. When the membranes are old, the quality of water usually decreases whereas the working pressure increases. If chemical washings do not produce significant improvements, it is recommended to replace the membranes.

6.9 Adjustments

Accumulator

This is a cylindrical plastic receptacle of air that has the function of damping the pressure oscillations during the commutations of the watermaker. The accumulator is factory loaded at a pressure of about 4 bar. The charging pressure of the dampener must be periodically checked.

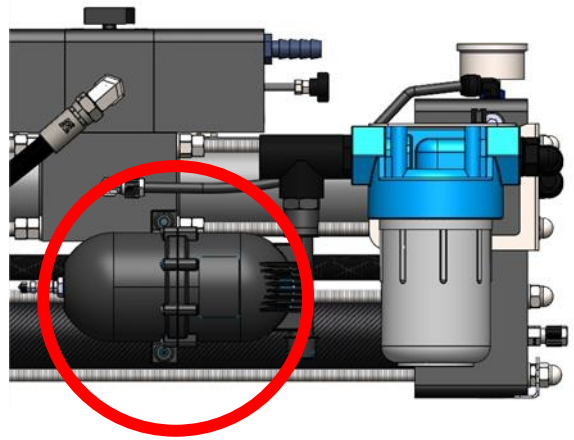

7. TROUBLESHOOTING

7.1 Troubleshooting chart

Issue	Probable cause	Remedy
Pump starts but the system suddenly blocks in high pressure	Hydraulic block	Perform reset procedure
	Dirty filters	Replace filters
High pressure variations during commutation (> 0,2 Bar)	Low pressure in the accumulator	Load at a pressure of about 4 bar
Low production / normal or low pressure	Low battery	Check battery charge
	Air within the system	Purge air by opening for a while the pressure valve
Low production / high pressure (> 9 Bar)	Clogged filter Clogged membrane Cold seawater	Replace filter Perform washing with SC1 Normal condition

8. SUGGESTED SPARE PARTS

8.1 Short term cruising

For short term cruising, it is advisable to have onboard a cleaning kit (one SC1 and one SC2 cleaning product) as well as one 5 micron cartridge filter. Other additional spare parts are listed below with their codes:

Spare part name	Code
SC1 WASHING PRODUCT	SC1
SC2 WASHING PRODUCT	SC2
CLEANING KIT (SC1+SC2)	CK
5 MICRON CARTRIDGE 5"	F5R

8.2 Long term cruising

For long term cruising, it is advisable to have onboard a Wiki Cruising Kit (four x 5 micron cartridges filter and one cleaning kit). Other additional spare parts are listed below with their codes:

Spare part name	Code
SC1 WASHING PRODUCT	SC1
SC2 WASHING PRODUCT	SC2
WIKI CRUISING KIT	CRKW
SPARE PUMP SM-MOD 30/60 12V	SP36/12
SPARE PUMP SM-MOD 30/60 24V	SP36/24
MEMBRANE 2521	M2521
PORTABLE SALINITY TESTER	PST
SPARE SEALS KIT	SSZ3